

THE TORSION FIELD AND THE AURA

by Claude Swanson, Ph.D.

ABSTRACT

The new sciences of biophotons and torsion fields provide a bridge between two views of life: the old twentieth century view of an organism as a chemical machine and the emerging view of life as communication and energetic flows. In the new paradigm, DNA is the source of biophotons, governing cellular machinery, communications and behavior. It governs growth and metabolism, with high energetic efficiency. The coherent biophoton field forms a hologram throughout the body, telling each DNA molecule where it fits in the overall blueprint, and governing cell differentiation and specialization.

With the creation of each biophoton there is also a torsion wave. Torsion is a widespread and important form of radiation which couples particle spins together, and propagates through space as a twisting wave in the metric. It results in a variety of new phenomena. These effects have been studied extensively for the past forty years, at multiple research centers in Russia. Their most important conclusion is that this torsion force is exactly the same as subtle energy.

Equations can predict torsion behavior, and inventions and practical devices have been developed using it. Although the biophotons carry electromagnetic energy and are contained mostly within the body, torsion waves easily penetrate tissue and form the primary holographic pattern outside the body. This includes the subtle structure of the aura and chakras, and also the long range signals used in distance energy healing.

The torsion field has been shown to couple to consciousness. It is a higher dimensional field, describing additional degrees of freedom absent in Western science today. Torsion fields obey Yang-Mills gauge equations, can alter the rate of time and produce stable energy forms without the need for matter. These fields can explain many kinds of "spiritual" phenomena ignored so far by mainstream physics. Torsion appears to be the missing ingredient which makes it possible to develop a true science of consciousness and understand the nature of life. Hence it may truly be called the "life force."

KEYWORDS: aura, torsion field, biophoton, consciousness, spirit, metabolism, growth, life force

THE TORSION FIELD AND THE AURA

“Time is the most important and most enigmatic property of nature. Time is not propagated like light waves; it appears immediately everywhere.”

– Dr. Nikolai Kozyrev (Ostrander, 1997)

“Spin acts as the source of the torsion field in the same manner as electric charge and mass produce electromagnetic and gravitation fields, respectively...A number of devices have been constructed, generating what appears to be torsion fields.” (Panov, 1997)

“Nikolai Alexandrovich Kozyrev’s ideas amaze our imagination. They are full of optimism. For the first time in physical constructions we can see vital, creative principles of the World, which are able to oppose to its heat death foretold by traditional physics to be inevitable.” (Shikhobalov, 2002)

“From the late 80’s till the late ‘90s, major experimental investigations were conducted that confirmed the theoretical predictions. It was established that torsion generators allow us not only to replicate all ‘phenomena’ demonstrated by so-called ‘psychics,’ but they also are able to demonstrate effects that were never demonstrated by any ‘psychic.’”

– Dr. Yu. V. Nachalov (Nachalov, 2003)

THE KOZYREV EFFECT: THE FLOW OF TIME AND TORSION

A breakthrough in understanding the nature of subtle energy has come from an unexpected direction. Dr. Nikolai Kozyrev, a respected Russian astrophysicist, announced almost fifty years ago that he had discovered a new force in physics that he called the “density of time.” He concluded that the rate at which time passes can be altered by other physical processes. Accompanying this would be a twisting effect in space he called torsion, which interacts with the spins of particles. Since every elementary particle, such as electrons and protons, have spin, this means that torsion is a universal force which has been overlooked by Western physics. It appears that this field may be the missing element in understanding the aura and other aspects of subtle energy.

As an astrophysicist, Kozyrev was studying how binary stars evolve. These are stars which orbit one another. He discovered that their behavior was not following accepted physics. They grew to resemble one another much faster than could be explained by known principles.

When he was interviewed by Sheila Ostrander and Lynn Schroeder in the late 1960’s for their ground breaking book *Psychic Discoveries Behind the Iron Curtain*, in which they devote an entire chapter to him, he said:

“There are pairs of stars we call double stars. At first the two stars are not the same, but gradually over a period of time the secondary star comes to resemble the primary star. It develops the same brightness, develops the same radius, becomes the same spectral type. At such enormous distances this mirroring couldn’t be happening through force fields. It would seem the principal star is affecting the satellite star through the energy of time. It’s almost as if the stars communed by telepathy,’ he said with a grin.” (Ostrander, 1970)

As he analyzed this behavior, he realized that he could explain it if time itself were variable. He theorized that whenever an irreversible process occurs, one which changes entropy¹ such as the burning inside a star, then it also affects the flow of time. This was the beginning of what has become a far-reaching and revolutionary new theory in physics.

Many physical processes are “irreversible” which means that they only run in one direction, from an ordered system to a disordered system. When a fire burns or a liquid evaporates, its energy and particles become spread over a larger volume. Energy escapes into space and cannot easily be recaptured. This is connected to a principle in physics called the Second Law of Thermodynamics, which says that entropy in a closed system can never decrease. It means that when the energy of a campfire log radiates away, it cannot be recaptured and used to recreate the log again, without putting in extra energy. This



Figure 1. Professor Nikolai Kozyrev

is an example of the increase of entropy in an “irreversible” process. Some have proposed that it is the increase of entropy which determines the passage of time. The two are closely coupled.

Kozyrev was troubled by this theory, because it led to the prediction that the Universe would “wind down,” ending eventually in a “heat death” in which all of the energy and matter was spread equally throughout the universe in a diffuse gas, without life and without structure. As an experimental astrophysicist, he observed that this was not happening:

"In the Universe, however, there are no signs of the degradation which is described in the Second Law [of Thermodynamics]. Stars die and are born again. The Universe sparkles with inexhaustible variety. In it one finds no traces of an upcoming thermal and radioactive death. Apparently here is where the basic contradiction lies – a deep contradiction which may not be explained away through a reference to nonapplicability of the Second Law to the infinity of the Universe. The fact is that not only separate stellar bodies, but whole systems are isolated from each other to a degree that they may be regarded as closed systems, for all practical purposes (usually the Second law is applied only to closed systems.) For them the thermal death could visibly draw nearer before any aid could come from outside. Such systems, in a state of degradation, should prevail in the universe, and yet they are almost non-existent." (Kozyrev, 1958)

From observations such as this, Kozyrev arrived at his theory of "torsion" and "time density," which concludes that when entropy increases in one place, it decreases elsewhere. This avoids the "heat death" scenario. His theory states that whenever an irreversible process occurs, which leads to a local change of entropy, that this change causes a local change in the density of time, and this change is radiated away in a twisting wave carrying "torsion" which will be absorbed at some other location. The absorption of the wave causes an entropy change in the opposite direction at the point of absorption. The overall entropy for the system therefore does not change.

One consequence of this proposal is that "torsion" can be stored in an object and transferred from one object to another. In this way its behavior is similar to electric charge, but it is not "conserved." It decays slowly over time. The storage time varies from tens of seconds to many months depending on various factors. A wide variety of detection means have been used to measure this effect. It is independent of the type of detection used:

"Investigation of this effect has shown that samples of the substances placed near processes, emitting time, then after some time, they themselves have such an effect on the detector."(Korotaev, 1996)

This effect was also seen by von Reichenbach (Reichenbach, 1850) who used sensitives to observe and report it. He called it "od" and we call it "subtle energy" or the "life force." It has the same behavior as the Russian "torsion." According to many Russian scientists, **torsion IS subtle energy.** It is responsible for the effects we have described throughout this book, such as the aura and long distance healing.

Kozyrev realized that time density would imply that space must also have a twisting property. He reasoned that if time is asymmetric, then space must also be. Every particle which has a mass, such as electrons, protons and neutrons, also has a spin. Every time such a particle accelerates, it must produce a twisting effect in space because of its spin. Entropy changes usually involve accelerations of particles, and therefore should affect this twisting property, which he named

torsion. Consequently, whenever a charged particle produces electromagnetic waves, or photons, it also creates torsion waves. As a result, torsion is a widespread and important form of radiation which couples particle spins together. Although its effects are usually weaker than electromagnetism, they are widespread and result in new phenomena.

When an “irreversible” process increases entropy in one location, it radiates torsion or time density, which will then be absorbed elsewhere. At the point of absorption **negative entropy is produced which balances the entropy increase at the source.** This is an extremely important principle. It ensures that the entropy of the entire universe does not increase. Kozyrev would say this happens because the flow of time compensates for the entropy increase.

Of this “physical property of time, the density of time,” Adamenko says:

“This physical component of time [the time density] can be ‘absorbed’ or ‘radiated’ by substances. So ‘density’ reflects the active property of time. The experiments carried out using special detectors showed that near the systems in which entropy increases, the density of time increases too. Consequently in this process the order, lost when entropy increases in one system, can be transmitted by changing the density of time, to the substance of the detector, increasing its order. So the elasticity, the conductivity, the work function of electrons (in photoelectronic processes) of the substance changes. These phenomena were confirmed by experiments (Kozyrev, 1978; Kozyrev, 1980).” (Adamenko, 1989)

In other words, the torsion wave carries the density of time, and in the process ensures that overall, when all the processes in the universe are taken into account, total entropy does not increase. Information is not lost. An increase somewhere leads to a decrease elsewhere, at the location where the torsion radiation is absorbed. This is summarized by Figure 2.

In addition, this flow is virtually instantaneous:

“Time does not propagate (for example like electromagnetic waves) but appears at once all over the Universe. That is why the connection through time must be an instantaneous one. So it is possible to observe some phenomena of very far astronomical bodies in real time, without delay. This perspective does not contradict the special theory of relativity because, when we have instantantaneous connection through time, there are not movements of material objects.” (Kozyrev, 1976)

Kozyrev’s ideas, although startling and revolutionary, have been carefully tested and verified over four decades by many dozens of physicists in Russia. It is indeed surprising that these results are not more widely known in the West. Their most important conclusion is **that this force, which Kozyrev calls torsion, is exactly the same as subtle energy.** Equations have been developed which predict its behavior, and inventions and practical devices have been developed using it.

While Kozyrev’s work stands on its own, it has been verified by many other Russian

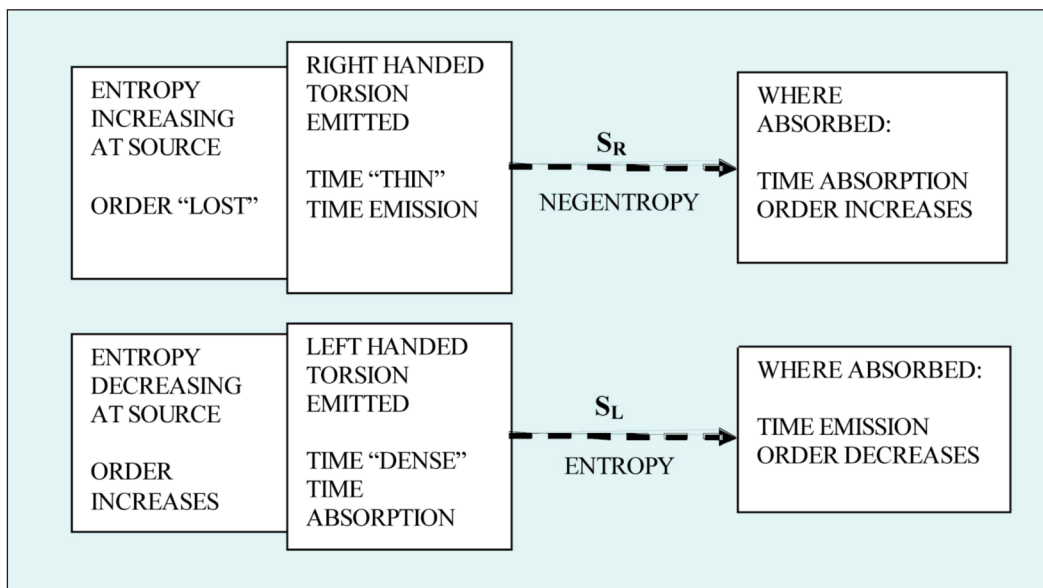

Figure 2. According to Kozyrev, total entropy and “information” in the universe is conserved. When entropy increases somewhere, due to an “irreversible” process, the lost information is carried away by (right handed) torsion waves, and deposited at the location where the torsion is absorbed. Time density is said to be “thin” at the source, where the entropy is increasing, and “dense” at the location where the torsion waves are absorbed. The reverse process can be considered as a time reversed version of the first one. A site where entropy locally decreases produces left handed torsion. Entropy will increase at the site where these waves are absorbed.

scientists (Levich, 1996; Lavrentiev, 1990, 1991; Panov, 1997; Lunev, 1995; Akimov, 1996). It is consistent with earlier Western researchers, such as Baron Karl von Reichenbach and Dr. Wilhelm Reich, with Traditional Chinese Medicine, and with modern Western scientists such as Dr. William Tiller (Tiller, 2001, 2005).

This research as well as other supporting material, is compiled in two books by Dr. Swanson, referred to here as Volume I (Swanson, 2003), *The Synchronized Universe*, and Volume II (Swanson, 2009), entitled *Life Force: The Scientific Basis*. The theoretical model presented there is referred to as the Synchronized Universe Model, or

SUM. It is defined in Volume I and II, and appears to provide a useful intuitive framework for understanding some aspects of Kozyrev’s torsion theory.

EXPERIMENTAL SUPPORT FOR TORSION

Many Russian scientists have concluded that Kozyrev’s discoveries constitute an important breakthrough in physics. Extensive research programs have been carried out to verify or extend various aspects of it. For example, the Tomsk Polytechnical University conducted a multi-year program investigating various aspects of torsion, both techniques for

generating it and measuring it. One report from that institution lists 19 scientists as authors (Lunev, 1995), and describes work conducted over a ten year period starting in 1983. The report bibliography lists hundreds of other reports which were published over this time period. Most of them were experimental and support the reality of torsion as an important phenomenon.

Other research has been summarized by respected scientist Dr. A. P. Levich of Moscow University (Levich, 1996), who states:

“N.A. Kozyrev, an outstanding astronomer and natural scientist, enriched the dynamic picture of the world by introducing a new entity, possessing ‘active properties,’ and coinciding with neither matter, nor field, nor space-time in its usual understanding.”

Levich’s report describes experiments by dozens of Russian scientists who verified Kozyrev’s predictions using torsion balances, resistance bridges, photocells, piezoelectric elements, mercury thermometers, chemical reactions, and changes of mass and density. It describes experiments which validate Kozyrev’s ideas in astronomy, electromagnetism, gravity and subtle energy. It indicates that subtle energy, in the guise of torsion, is well on its way to being accepted as a “hard science” complete with experimental validation, theory and applications.

Nikolai Kozyrev’s research on torsion began in the 1950’s. By 1969 when he was interviewed by Sheila Ostrander and Lynn Schroeder for *Psychic Discoveries Behind*

the Iron Curtain (Ostrander, 1970) many aspects had already been experimentally verified, and were receiving governmental research support. One torsion scientist, Shakparonov, commented that his results were based on a 30 year collaboration by eight different laboratories (Shakhparonov, 1999). Many of the results were only published after *glasnost* in 1991, when security restrictions relaxed. The number of physicists and institutions involved indicate that torsion is a genuine scientific phenomenon.

Professor Panov of Perm University summarized some of the experimental evidence:

“In the experiments performed in the seventies and eighties in Dubna, Protvino, and also in Brookhaven and Argonne National Laboratories, it has been shown that protons with spins in opposition to the spins of target protonic polarization travel through target protons, as A. Krish put it, as if without interaction (Akimov, 1996), whereas for identical orientation of spins of protons in the beam and target, scattering occurs in satisfactory agreement with the theory, The unusual behavior of spinning particles was observed with particle accelerators of various types in many experiments.

“V.G. Baryshevski and M.I. Podgoretski have found experimentally that precession of neutrons occurs when they pass through a spin-polarized target, corresponding in magnitude to a field several orders of magnitude stronger than the magnetic

field of the target nuclei (Baryshevski, 1964). R. Irabert discovered that circular polarized electromagnetic waves deviate from the plane of incidence (Imbert, 1972), the direction of deviation dependent on the spin... Taken together, the above results, as well as some other findings, give enough reason to suggest the existence of interactions and fields of a particular kind with classical spins or angular momenta acting as their source. Spin acts as the source of torsion field in the same manner as electric charge and mass produce electromagnetic and gravitational fields, respectively. [emphasis added]” (Panov, 1997)

Russian scientists have found that torsion also explains unusual effects correlated over distance, such as “the so-called kineto-baric effect” (Peshka, 1979), Picardi’s 25-year observation of the Bismuth Chloride precipitation rate, the rate of erythrocyte precipitation (Meksi, 1982), flicker noise (Zhvirblis, 1983) as well as the many observations of Kozyrev, and A. Shapovalov’s three year observations of photomultiplier ‘dark current’ (Shapovalov, 1973).

Such experiments describe “correlated anomalies,” which means anomalies which are seen simultaneously in many locations. Dr. William Tiller has shown that in certain “conditioned spaces,” which means spaces charged with subtle energy, anomalies can appear which are periodic and coupled over large distances, even between laboratories in different States (Tiller, 2001, 2005). This coupling over long distances of anomalous effects appears to be connected to the other

long range correlations listed. The proposal is that the background torsion field may mediate all of these effects. In Volume II we explain such phenomena as due to a “beat frequency” between two parallel physical realities or synchronized planes. Such effects can occur when subtle energy or torsion has “raised the gauge,” (to use Dr. Tiller’s apt expression.)

Kozyrev’s theory explains anomalies observed in gravitation, such as the eclipse experiments of Saxl and Allais (Saxl, 1967, 1971, 1996; Allais, 1957a-e, 1959), referred to in Volume II. It may explain why NASA satellites are not moving as predicted as they move outward in the solar system (Flandern, 1997). Even more exciting, it may explain “dark matter” and “dark energy,” two phenomena which have puzzled astronomers in recent years.

Dr. Gennady Shipov (Shipov, 1993) developed a rigorous mathematical theory for torsion, and his predictions have been confirmed by several Russian scientists (Akimov, 1995, 1997). Others including De Sabbata and Gasperini (De Sabbata, 1980, 1981), Hammond (Hammond, 1999), Evans (Evans, 2003) and Veinik (Veinik, 1991) have authored competing theories, all of which include some form of torsion, so it is probably too early to render a verdict on the “final torsion theory.”

The effect of torsion can be seen in the simple lab experiments Kozyrev conducted. In the presence of an “irreversible process”, such as the evaporation of acetone, for example, a force was created resembling

gravity. Depending upon the sign of the entropy change, **this force could be either attractive or repulsive.** These two polarities also correspond to the two polarities of yin and yang described in earlier chapters, and to the positive and negative od studied by von Reichenbach. In fact, Kozyrev found that he could create these same two polarities of subtle energy in the laboratory by introducing irreversible processes. They may offer an alternative explanation for the origin of dark matter and dark energy which is puzzling astrophysicists.

LABORATORY RESULTS ON TIME AND TORSION

The nature of Kozyrev's "torsion" and "time density" can be best understood by describing some experiments.

According to Kozyrev, torsion is created by an "irreversible process," one in which entropy is changed. A good example of an irreversible process is the evaporation of acetone, a cleaning fluid. Evaporation of water will also work, but acetone evaporates much faster and produces a stronger effect. In evaporation, energy flow is inward to the liquid. By the definition of entropy, this means it must increase during this process. Because the molecules occupy a larger volume after evaporation, we have less information about their location, so information about the system has reduced. This is another meaning of "entropy increase."

The figure below (Figure 3) sketches two different devices which Kozyrev used to measure torsion effects. They are very sensitive and capable of registering weak

Figure 3. Show basic simple Kozyrev experiment, elastic band and uneven torsion pendulum with gyroscope.

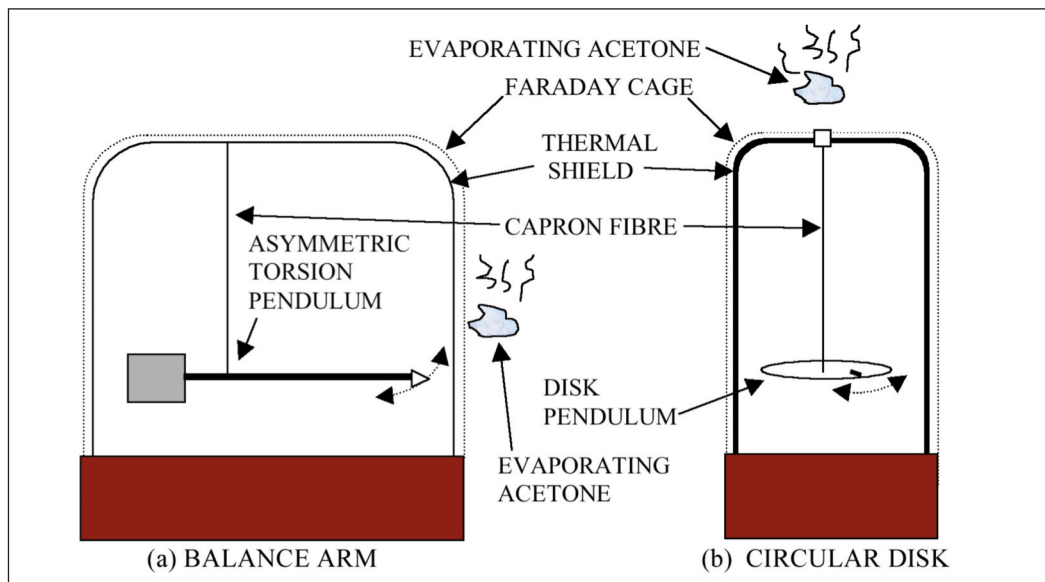

forces and torques. Devices of this kind were used centuries ago to measure gravity in the laboratory. Other scientists including Lavrentiev (Lavrentiev, 1991) have replicated and extended Kozyrev's experiments, so at the present time these effects have been very rigorously demonstrated in Russia.

The devices are called "torsion pendulums" and are very simple, in principle. They consist of a balance arm suspended by a fine thread. One version, the asymmetric torsion balance, used a small mass on a long arm, and a large mass on a short arm, as shown in the left frame of Figure 3. The lengths of the arms are chosen to balance the two masses. All the air is pumped out of the container to eliminate effects of air motion. A Faraday cage was placed around the detector to minimize electromagnetic disturbances. Thermal insulation was used to guard against temperature effects.

Then Kozyrev placed a source of "time density" near the long arm and monitored what happened. He found that processes which increase entropy, such as evaporation of acetone, always **repelled** the small mass on the long arm. In his terminology such processes "emit time," and create right handed torsion, denoted by S_R . No matter on which side of the arm the acetone was placed, it had the effect of pushing the small mass away.

When instead he used a source of negative entropy, such as the freezing of ice, Kozyrev found that **it caused an attraction of the small mass**. Kozyrev said of such processes

that they "absorb time," producing left handed torsion, denoted S_L . It created an attractive force, very similar to gravity though stronger. He found that the force did not depend on the composition of the mass, only its weight. He concluded that processes which are negentropic and "absorb time" generate a force which attracts, while sources which increase entropy "emit time," generating a force which repels.

Kozyrev found that the motion of the pendulum behaves as if "time density" or torsion is similar to gravity. Near a "cause," there is "time emission," and the lines of time stream away from the source. This is a region which repels the small mass of the torsion balance. It is as if "time emission" is the same as negative gravity, or antigravity. Conversely, a region of decreasing entropy, or "time absorption," in which time is "dense" in Kozyrev's terminology, behaves as though gravity is increased. Such regions produce a weak attractive force, pulling the small mass to them.

These observations help explain a mysterious Russian term from the 1970's: "biogravity." Ever since the writings of Dubrov in the 1960's (Dubrov, 1973, 1977), Russian scientists have associated subtle energy with the term "biogravity." Dubrov even wrote a book titled *Biogravitation* (Dubrov, 1973). There were a number of PK experiments conducted during that period, and it was often hinted that they could be explained by "biogravity," without explaining what it was. In chapter 8, from the work of Robert

Pavlitia, we will see an inventor who learned to control this energy to produce attraction or repulsion forces. In some cases it can be even stronger than magnetism and works under water unlike electrostatic forces. This appears to be the same force used by Kozyrev to move the torsion pendulum.

In some of his experiments a different type of torsion balance was used: a flat circle suspended in the center, instead of the long torsion arm. This is shown in the right hand diagram of Figure 3. Because of the symmetry of the suspended circle, the “gravitational” force of attraction or repulsion does not affect its motion in this case. However, Kozyrev found that placing evaporating acetone or some other irreversible process near the support point at the top of the thread had an effect. It caused the circular disk to rotate!

The direction of rotation of the disk was consistent with the direction of twist of the torsion which flowed down the thread from the irreversible process at the top. In this way Kozyrev verified that **torsion carries a twisting motion**, and can produce a force on physical objects.

Processes in which **entropy increases**, such as acetone evaporation, caused the disk to rotate **clockwise**, as viewed from above. This means the disk twisted “to the right,” looking downward in the direction the torsion was flowing. Conversely, processes in which **entropy decreased** (left handed torsion, time absorption) caused the circle to rotate **counter-clockwise**, or to the left. This is consistent with the torsion twist direction.

Kozyrev used this type of detector in later telescope applications, since light from distant objects could be focused on the small support point at the top. He was thereby able to measure not only the presence of torsion energy of remote objects, but also the polarity of the energy. And the amount of the twist measured the strength of the torsion signal.

The mercury level in a thermometer can serve as a detector of torsion, because mercury, as well as other materials, expands or contracts in response to torsion (Kozyrev, 1982). Temperature effects must be carefully removed first, since obviously thermometers also respond to temperature. This can be done by placing the thermometer in an insulated container. Other processes which can serve as detectors include electrical resistance, water viscosity, chemical reaction rate, and the growth rate of plants and bacteria. In each case, the effects are small so they must be implemented with some care and sophistication.

Although they penetrate through materials, each substance is different. Aluminum is said to reflect about 50% of a torsion wave, and materials with chiral (twisting) organic molecules each reflect torsion differently, based on the polarization of the wave. This creates a “torsion filter.”

Torsion waves twist to either the right or left as they move through space. When they pass through materials with the correct molecular make-up, with molecules which twist to the left or right, they will either pass through or be partially absorbed. This is one exception to the rule that torsion “penetrates all materials.”

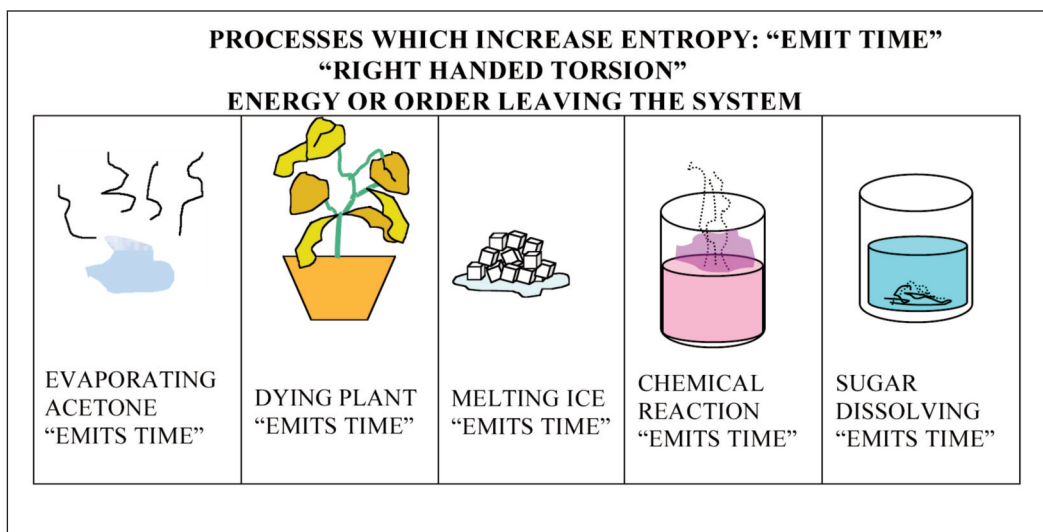

Figure 4. Examples of processes which “emit time,” in which entropy increases and right handed torsion or “negative od” is produced.

In Kozyrev’s early 1967 paper he described materials of this type:

“It turned out that [torsion] balances can be shielded, to a considerable extent, from these influences by placing near them an organic substance consisting only of right-handed molecules: for example, sugar. The left-handed molecules – e.g. turpentine – evidently cause the opposite effect.” (Kozyrev, 1967)

This observation emphasizes the importance of “handedness” in biological molecules. According to Kozyrev, the molecular handedness can filter out one spin direction and allow the other to come through. It may be connected to the “twist” in acupuncture points when they become stimulated, as reported by Prof. Joie Jones (Jones, 2002, 2004a). **Such a twisting of tissue can act as a “valve,” allowing one polarity of torsion energy (subtle energy, or chi) to pass**

through while stopping the other polarity. It may be an important mechanism in the acupuncture system. Obviously such a far-reaching proposal needs to be tested, but if verified it could provide valuable insight into how the body’s acupuncture meridian network regulates the flow of chi.

Figure 4 illustrates some of the processes tested by Kozyrev which locally increase entropy, or “emit time.” Among the processes tested were evaporation of acetone, dying of plants, melting of ice, chemical reactions, and dissolution of materials such as sugar in water. Each process produces right hand torsion. In each case, the process **repelled the pointer** on the asymmetric pendulum and caused the circular pendulum to rotate to the right.

Conversely, Kozyrev tested other processes which decrease entropy. These involved

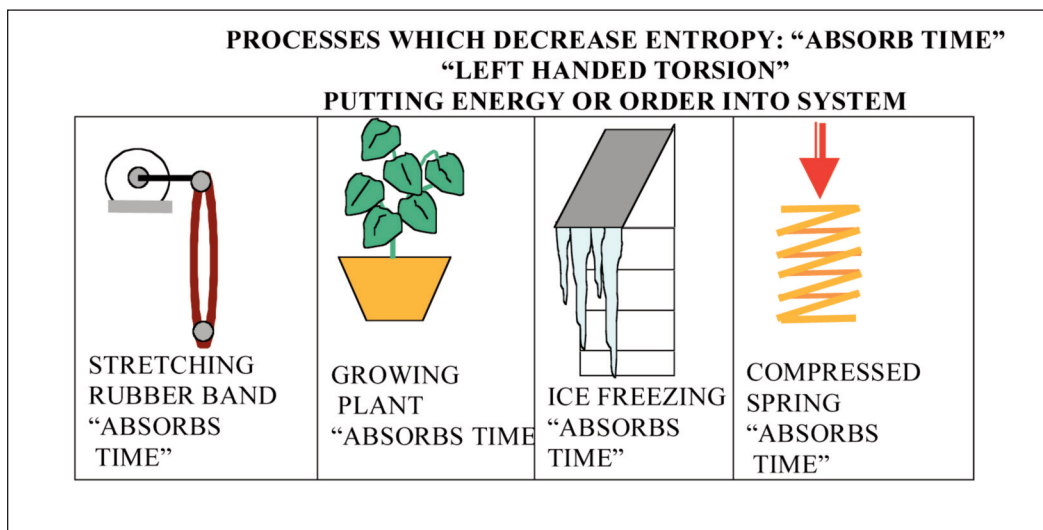

Figure 5. Examples of processes which “absorb time,” in which entropy decreases and left handed torsion or “positive od” is produced.

cooling of an object, the stretching of a rubber band, the compressing of a spring, the growing of a healthy plant, and the freezing of ice. They are illustrated in Figure 5. In Kozyrev’s terminology, these processes are associated with “absorbing time.” In each of them, the long pointer on the balance arm moved **toward** the process. The circular pendulum rotated to the left. They are all examples of “left handed torsion.”

One polarity is associated with stimulating growth and life. The other slows time and is associated with rest. This corresponds to the two polarities of *yang* and *yin* in Chinese medicine. It also corresponds to the two polarities of *od* described by Baron von Reichenbach. This is the same energy. Once again someone has “discovered” subtle energy! But a great deal that is new has been learned in the process.

“N.A.Kozyrev has given the following, unfortunately, intuitive interpretation of those facts. The process emitting time is the one losing organization, or in another way – emitting negentropy.” (Korotaeu, 1996)

Kozyrev found that torsion is created in abundance by fields of flowers in the spring-time, and is also present in sunshine. This was also discovered by von Reichenbach. When he created an “irreversible process,” such as mixing two liquids together, or dissolving sugar in water, Reichenbach found the process created large quantities of subtle energy, which he called “od” and which Kozyrev calls “torsion” or “time density.”

The torsion emitted by plants is a particularly interesting case. Note that a dying plant emits right handed torsion, which is associated with a process in which entropy is increasing at the source. This implies

that entropy is increasing inside a dying plant. This makes sense, because its biological structures are breaking down. By contrast, a growing plant is a source of local decrease of entropy, since it is actively building complex tissues and structures. Based on Russian observations, metabolism is negentropic. Therefore it “absorbs time.”

It is useful to keep in mind the dual nature of torsion waves. A locale in which entropy is increasing locally is a site where randomness is increasing and information is being lost. But according to Kozyrev, this information is carried away by the torsion waves, and will be deposited wherever the torsion is absorbed. According to this relationship, therefore, **living creatures emit left handed torsion.**

CHANGING MASS AND DENSITY

One prediction of Kozyrev was that the “density of time” would affect the mass of ordinary matter. To test this, Academician Lavrentiev and his team built a reflecting chamber with an “irreversible process” at one end, and the mass or density to be affected at the other. Any sound or light signal from one focal point will be focussed onto the other focal point. The conceptual design of the experiment is illustrated in Figure 6.

An irreversible process is allowed to proceed at the focal point on the left end of the chamber (Lavrentiev, 1991). The resulting torsion reflects from the mirrored walls and

is then focused on an experiment at the second focal point on the right hand side. In Lavrentiev’s experiment, there was a distance of 40 centimeters between the two focal points. At the first focal point, on the left, he placed a sealed container inside of which an irreversible process could occur. One example was a sealed flask of liquid nitrogen which was allowed to evaporate, turning from a liquid to a gas. Sawdust was included in the flask to absorb the vapor. Other irreversible processes included sugar dissolving in water, and the cooling of hot water.

At the second focal point was placed the system to be affected. There were two principal types of mass experiments. In one type, the mass was suspended from the balance, but it was submerged in a beaker of distilled water. In this case, the density of water was also affected by the irreversible process. Changes in the water density altered the buoyancy of the weight, which led to a change in the measured weight on the balance. In the other type, there was no water and the mass was measured directly.

The experimenters were well aware of temperature effects and other possible sources of error, and took great pains to eliminate them. They called in members of the “State Inspection for the Mechanical Means of Measurement,” similar to our National Bureau of Standards, now called NIST, which is the expert on very accurate measurements. This group was asked to observe and verify their measurement methods.

To further eliminate error, they took further precautions:

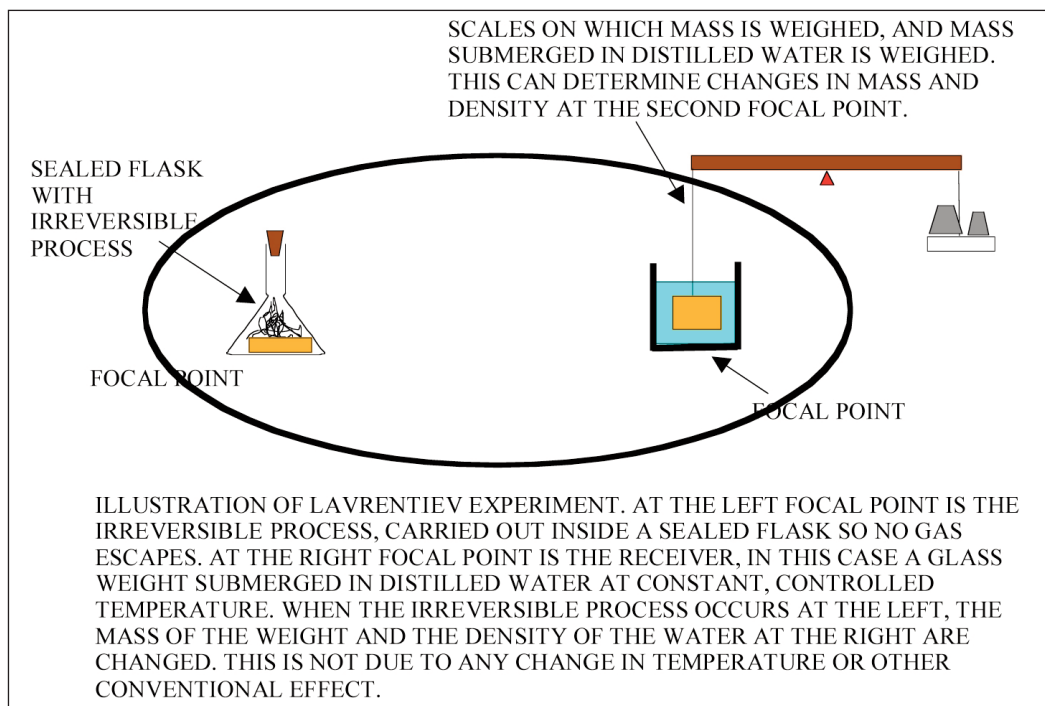

Figure 6. Illustration of one type of experiment conducted by Kozyrev and later replicated by Lavrentiev. A physical process is allowed to occur at the left end of the chamber. In this example, it is an irreversible process, the evaporation or mixing of chemicals. A signal is emitted from such processes, and it can be reflected and refocused on the right hand side, where it creates unusual effects such as the alteration of mass and density.

“The possibility of mass changes due to known phenomena (electrostatics, adsorption, and absorption, changes in the buoyant force, etc.) were studied in cycles of special experiments. Systematic mass measurements of 16 objects over a year detected mass changes uncorrelated with changes in atmospheric pressure, humidity or temperature. A cycle of experiments was carried out on specially fabricated objects of Dural and brass with built-in thermometers, with differing shapes and masses, and with electrical heaters provided with contact screens of various kinds: of asbestos, marble, copper, etc. The

correlation of the dynamics of the mass variations and the dynamics of the temperature variations were investigated. The set of results cannot be related in principle with these known phenomena.”
(Lavrentiev, 1991)

Figure 7 shows some of the results of these measurements. A metallic mass is weighed while submerged in water. Torsion affects both the mass of the object and the density of the water. An increase in water density will reduce the measured weight at the scales, due to buoyancy. The two effects are in opposite directions, but the effect of

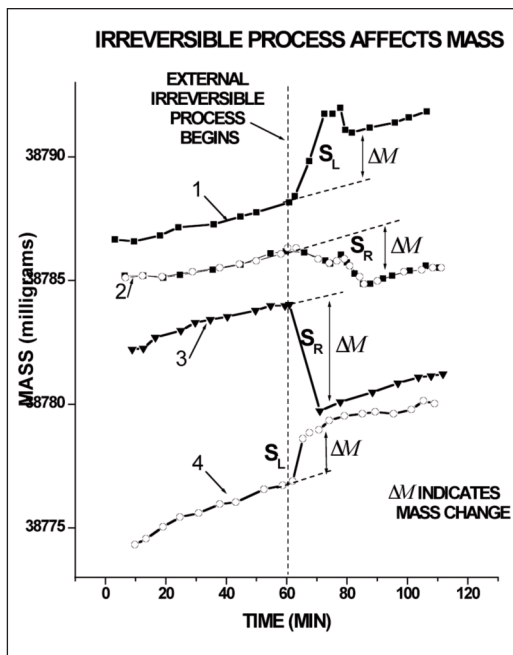

Figure 7. Four curves are plotted on the graph, corresponding to four different cases. The first and fourth from top down are caused by entropy decreasing processes, producing left handed torsion, S_L . The second and third cases are caused by entropy increasing processes, which generate right handed torsion, S_R . The horizontal axis is time, in minutes. M is the mass of the glass float.

Case [1] is the cooling of boiling water, where $\Delta M = 3.50 \pm 0.15 \text{ mg}$, $\Delta \rho = -(1.5 \ 0.1) \text{ g/cm}^2$;

Case [2] is sugar dissolution in water, 6 minutes, where $\Delta M = 2.20 \pm 0.15 \text{ mg}$, $\Delta \rho = +(0.9 \ 0.1) \text{ g/cm}^2$;

Case [3] is liquid nitrogen evaporation, 6 minutes, where $\Delta M = -4.65 \pm 0.1 \text{ mg}$, $\Delta \rho = +(1.9 \ 0.1) \text{ g/cm}^2$;

Case [4] is human metabolism, 1 minute, where $\Delta M = 1.8 \pm 0.15 \text{ mg}$, $\Delta \rho = -(0.7 \ 0.1) \text{ g/cm}^2$;

the water density is the larger effect. The vertical axis displays the resulting weight, in grams, which combines these two effects. The resulting weight of the object is shown on the vertical axis, measured in milligrams or thousandths of a gram, accurate to five decimal places.

When the irreversible process begins, the water density changes. This causes an abrupt change on the measured value. Using this technique, when the scales show a **decrease** in the weight, it means that the weight is more buoyant because the water has become denser. A decrease in measured mass means an increase in water density.

In the figure, four curves are plotted, corresponding to four different cases. The horizontal axis is time, in minutes. The flask containing the irreversible process is placed at the left-hand focal point of the chamber, but it is not started until after the system has settled down. Then, at a given moment marked as "60 minutes" on the graph, the irreversible process begins. At that moment, a change in the density of the water occurs in every case.

In the top curve, the irreversible process is the cooling of boiling water. At the starting time, the boiling water begins to cool. At the same moment the mass at the second focal point shows an increase in weight corresponding to a **decrease** in the density of the water. The change is several milligrams.

In the second curve, the irreversible process is the dissolving of sugar into water. This causes a decrease in the measured mass on

the right, meaning the water there is now denser. In this case entropy is increasing because of the freedom of mixing of the two types of molecules. No significant energy exchange occurs.

An even stronger effect is seen in the third curve, in which liquid nitrogen is allowed to evaporate. Here, again, entropy at the source increases because of the additional degrees of freedom of the nitrogen molecules. The measured weight drops suddenly by more than four milligrams.

The last curve uses human metabolism. From other experiments such as the torsion pendulum, it was already known that metabolism is negentropic. This illustrates how efficient life processes are in rebuilding protein and tissue.

Note that in Cases 2 and 3, entropy is **increasing** at the source. This produces right handed torsion, marked S_R . In Cases 1 and 4 entropy **decreases** at the source, which produces left handed torsion, S_L . In all cases the measured change on the scales is opposite the direction of entropy change. These and other experiments confirmed the effect of torsion on changes in weight and density. Academician Lavrentiev concluded:

“...the entire set of properties of the dynamics of change in mass and density of substance, including the aftereffect noted by us (continuation of the change in density and mass after cessation of the effect) is indicative of a change in mass as a measure of the gravitational (inertial) property of the substance, and not as a

measure of the amount of the substance.”
(Lavrentiev, 1991)

Experiments were also performed measuring the mass directly, without the buoyancy of water. These also showed the expected effects. These anomalous changes in mass and density, which are consistent with Kozyrev’s torsion field, have also been observed in chemical experiments in Germany. A series of tests were carried out by Klaus Volkamer et al. to determine how well conservation of mass holds in chemical reactions. They observed significant mass changes, consistent with the effects of torsion:

“Using modern sensitive, and in one case automatic, weighing techniques, the results obtained reveal time-dependent and long-range gravitational irregularities which are many orders of magnitude larger than expected relativistic-mass effects, indicating an apparent violation of conservation of mass in this special chemical reaction.”
(Volkamer, 1994)

ASTRONOMICAL OBSERVATIONS

In another series of fascinating experiments, Lavrentiev and his team placed an electrical element, a special resistor, at the “receiving” end of a reflecting telescope (Lavrentiev, 1990). The diagram in Figure 8 illustrates this design.

The sun is the source of powerful irreversible processes, including nuclear fusion, as well as turbulence in the solar

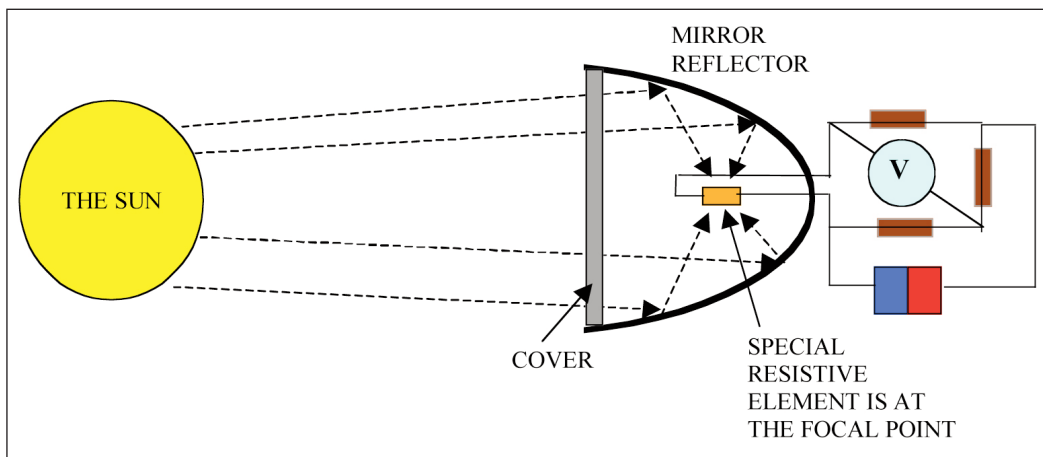

Figure 8. Detection of torsion emitted by the sun. This system was also used to measure the torsion radiation from stars and planets. On the left (at great distance!) is the object being observed, the sun or stars. On the right is a telescope with parabolic mirror, which focuses the torsion waves on a detector. A metallic cover is placed over the telescope to exclude normal light. The detector in this case is a network of resistors (Wheatstone Bridge). Certain resistor materials such as tungsten showed the largest change in resistance when exposed to torsion energy. The design was carefully tested to ensure that no conventional energy reached the resistor. Other torsion detectors, such as Kozyrev's torsion pendulums, were also used successfully.

plasma and evaporation of heated particles as solar wind. In Lavrentiev's experiment, a parabolic aluminum mirror was used to focus the sun's radiation onto a "special resistive element." The mirror used was part of the 50 inch diameter telescope at the Crimean Astrophysical Observatory of the Academy of Sciences USSR.

One of Kozyrev's many discoveries was that, despite the ability of torsion waves to penetrate most materials, aluminum does reflect a portion of the wave (about 50%). This fact was used in numerous experiments as a means to concentrate the torsion energy.

Kozyrev had already demonstrated that resistors are affected by torsion. Some of the most sensitive detectors contain biological material, while others use thin film tungsten. The resistors are depicted in the

diagram, placed in a "bridge" circuit which can be used to measure small changes in resistance. Another successful design used a colony of *E. coli* bacteria. Exposure to the torsion energy alters their growth rate.

These telescope "detectors" were calibrated with other "irreversible processes" in the laboratory, such as evaporation of acetone and the dissolving of sugar in water. Both the metal film resistor and the biological sensor made good detectors. Over twenty materials were evaluated as sensors. In operation, an aluminum alloy screen and an opaque cover were placed over the front of the telescope. This shielded out all of the conventional solar radiation, including light and heat. Consequently, radiation traveling from the sun to the telescope can represent only the torsion waves.

As the telescope was scanned past the sun, the voltage across the resistor array varied strongly, indicating changes in the intensity of torsion energy impinging upon it. Figure 9 shows two traces of the resulting output signal. The telescope direction was scanned at a constant rate (the rate the earth was turning) across the sky, so even though the horizontal axis is given in minutes of time, it actually represents direction in the sky. The vertical axis on the graph measures the signal strength of the detector. This creates a one-dimensional map of torsion brightness across the sky.

There is a strong peak in the signal at the location corresponding to the **instantaneous** position of the sun. This is marked as the “true position” in the graphs. This is the direction that the sun would appear in the sky at that moment if light propagated with **infinite** speed. There is also a weaker signal which appears on the right side of the graphs corresponding to the apparent position of the sun to the eye, which is caused by the 8.3 minute delay light required for light to travel to the earth.

There is also a third signal in the graphs, about 8.3 minutes on the **other** side of the true position. This corresponds to the actual **future** position of the sun 8.3 minutes later. It corresponds to the direction of the sun if light traveled **backwards** in time from the sun to the earth. This is called the “advanced waved.”

Although these experiments were conducted by Academician M.M. Lavrentiev, similar experimental data was presented by Dr.

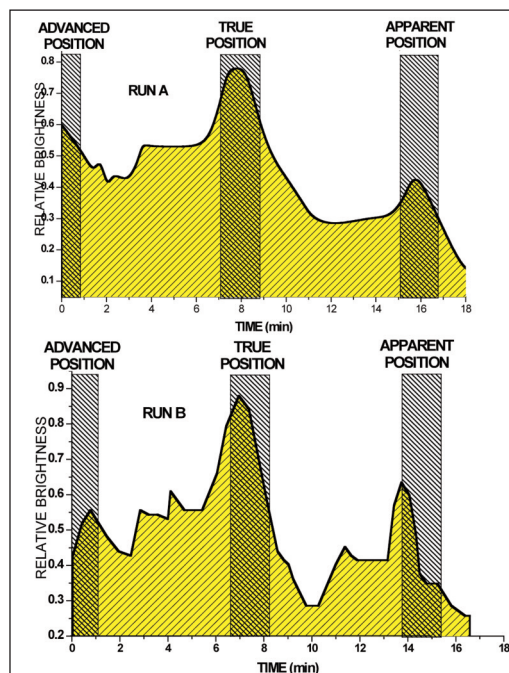

Figure 9. Reaction of the resistance bridge output to two independent scans past the sun. Note that the largest signal corresponds to the instantaneous direction of the sun, not the “retarded” or time-delayed position which is its apparent position as we would judge by eye. (Lavrentiev, 1990)

Viktor Adamaneko in a lecture at the Seventh International IAPR meeting, in Carrolton, Georgia, USA in 1988. I was fortunate to attend this talk and speak to him afterwards about the experiment. He explained that some of the signals detected by the telescope appear to propagate **instantaneously** or even **backward** in time:

“This is why a connection through time must be an instantaneous one. So it is possible to observe some phenomena of

very far astronomical objects in real time, without delay, using special detectors of physical properties of time. N. Kozyrev and V. Nasonov carried out some experiments in the Crimean Astrophysical Observatory in 1978-1980 to determine true and apparent star positions. They discovered that the detector of physical properties of time "feels" changes at three points in the sky:

- a) position of the astronomical object at the present moment*
- b) position of the astronomical object in the past*
- c) position of the astronomical object in the future, which the object would have if it were to receive a signal from the earth with the velocity of light."*
(Adamenko, 1988)

One issue which these measurements highlight is the propagation speed of the torsion signal through space. Light travels at 3×10^8 meters per second, which means it takes about 8.3 minutes to arrive at the earth from the sun. It appears that the torsion signal measured by the telescope has three components, one which travels at the speed, one which travels **backwards in time** at the speed of light, and one which travels at near infinite speed. There are many other results which support this observation.

This idea sounds even stranger than the Kozyrev notion of "time density", but actually it is a concept which is familiar to modern physicists. Nobel Laureate Richard Feynman created his space-time diagrams to illustrate how particles, and light, can travel

forward and backward in time. He pointed out that, mathematically, photons travelling backward in time are a legitimate solutions of Maxwell's equations. Nowadays, in Quantum Electrodynamics, it is not unusual to assume that light can go backwards in time over small distances. What is unusual is the possibility that a signal can go backwards in time over large distances, and that such effects can be detected. According to torsion theory, it is the interaction of particle spins of this type which can carry information but no energy, which makes this possible. This feature is one of many that make torsion waves unusual.

Observations of this type, in which faster-than-light signals are detected, support acupuncture measurements performed in the Soviet Union during solar flares. Doctor A. Podshibyakin, an electrophysiologist at the Institute of Clinical Physiology, Kiev, was measuring the acupoints of a human subject, using a tobiscope which measures the electrical conductivity properties of acupoints. He noticed that anomalies in the acupuncture voltages occurred **simultaneously** with strong solar flares on the sun. The occurrence of the acupuncture anomalies and the solar flares were not delayed by 8.3 minutes as would be expected if they were due to electromagnetic signals. He concluded that whatever was causing the acupuncture anomaly must travel much faster than light. It is now recognized that these signals were an early observation of torsion waves (LaMothe, 1972).

Lavrentiev and his team examined experimentally many of the predictions of Kozyrev's theory. He concluded:

“Not a single case was noted which contradicts the observations of Kozyrev, but further investigations are required to confirm his conclusions about the physical properties of the observed effect”
(Lavrentiev, 1990).

ORIGIN OF TORSION

Kozyrev's theory of torsion arose from his ideas about the basic nature of cause and effect. He postulated that in physical processes, the “cause” of an event and the “effect” are always separated by a small amount of space and time. One can think of the “cause” as an initial imbalance of forces in space, an imbalance of vacuum energy, and the “effect” as being the response which tries to bring it back into balance.

The cause and effect are separated by a small interval, which has the properties of a twisting vector. This leads to the notion that right handed twist is the polarity of subtle energy which moves time forward. It is probably connected to a deep asymmetry in physics involving the spin of elementary particles.

A force can arise along this line between the cause and the effect. To conserve momentum, the force along the line is balanced in both directions. However, according to Kozyrev's ideas, a small

twisting force along the line can arise. The direction of twist (right handed versus left handed) depends on whether entropy is increased or decreased at the point of origin. When entropy increases at one point due to an irreversible process, according to Kozyrev this alters the local “time density” and causes the generation of right handed torsion waves.

At some later point this torsion will be absorbed. This results in an increase in the “time density” and a decrease in entropy at that location. Consequently the torsion wave maintains overall balance in entropy for the entire system. Although entropy increased at the point of the “cause” its absorption elsewhere balances this. These torsion waves cannot be localized, so any process involves the entire system, the universe. As a result, according to Kozyrev, the assumption of the Second Law of Thermodynamics that it is possible to have an “isolated system” is false. There can be no isolated systems. Torsion and time density permeate the entire universe and couple any local process to every other particle.

This is similar to the Synchronized Universe Model we described in Volume I, which is based on the principle that every physical process involves an interaction with every other particle in the universe. This is another statement of Mach's Principle. Here we see it in a slightly different form, but the effect is the same. The universe is connected. A process in one place affects and is affected by every other process. This affects the flow of time as well as local forces everywhere.

As summarized by Kozyrev:

“Time carries order or negative entropy (negentropy) and it is either emitted by a system when its order decreases, or absorbed by a system when its order increases” (Kozyrev, 1991).

A related aspect of torsion is that rotating objects generate it. A spinning mass produces a twisting or torsion field around it. For a steadily spinning object, there is a steady torsion field extending from both ends of it. The “right-handed” torsion field, S_R , extends in one direction, and the left-handed field, S_L , in the other, along the axis of spin. This is shown in Figure 10. It undergoes several oscillations, then drops to zero with increasing distance away from the rotating object.

The sign of the spin field can be derived from the apparent direction of rotation of the object as seen from either side. Standing on the spin axis on the right hand side, and looking toward the sphere, it will appear to rotate counter clockwise, or to the left, S_L . Hence the torsion field in that location is left-handed, as marked on the Figure. Conversely, if one is on the left hand side in the diagram, then the sphere appears to spin clockwise, or to the right. Hence the stationary torsion field there is right handed, or S_R .

The arrow coming out the right side of the sphere denotes spin direction. It is based on the “right hand rule”. If the rotation is thought of in terms of turning a screw, then the direction of motion of the screw tells us

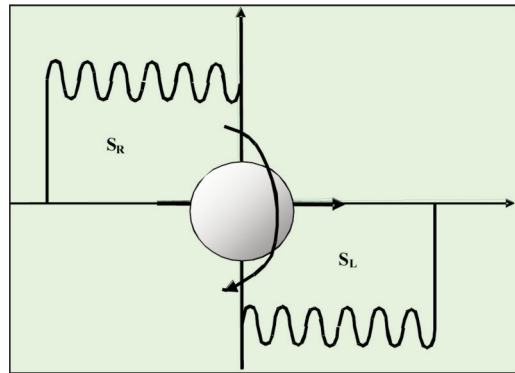

Figure 10. Static Spin Fields: Intensity of this fields modulates as a function of distance and drops off suddenly. Reason for this are still under investigation.

which way the spin axis points. In this case it is to the right.

Since every elementary particle with a mass also has a spin, each one generates its own natural torsion field around it. Einstein’s equations of General Relativity, which describe what happens in an accelerating frame, were written without taking into account the spin of elementary particles. Therefore, when a spinning particle accelerates, its behavior is not correctly described by Einstein’s equations. Russian torsion theorists have remedied this problem (Shipov, 1993). Shipov has extended Einstein’s equations to include particles with spin, and in the process has created a theory which predicts and includes the observed torsion effects. The predictions are in accord in a wide array of experiments (Akimov, 1992, 1997; Nachalov, 2004).

The difference between the acceleration of an ordinary non-spinning mass and a spinning mass can be illustrated in the following diagram, in Figure 11. In physics, there are equations which govern rotating bodies, called the Euler equations. Shipov has integrated them into the equations of motion. Conservation of angular momentum (spinning momentum) means that space itself is affected when a spinning object accelerates.

One way of seeing this is by considering how the energy of the vacuum must act to maintain the spin of a particle. There is a rotating field of energy around a spinning particle. When the particle accelerates, this field of energy must also accelerate. But for a particle undergoing self-orbits, its acceleration is different at different parts of the orbit. This will lead to a twisting of the energy field, and is the origin of torsion.

Another way of thinking about this is to consider what happens when a spinning particle accelerates. When sitting still, there is a radiation field which it creates and which radiates outward due to its motion. There is also an incoming radiation field which just balances it. But when a particle accelerates, the incoming field converges on the particle's **old position**. The particle is no longer there. It has accelerated away. This is illustrated in Figure 11.

An accelerating, spinning particle will leave a "wake" behind it, of energy flowing in and radiating out which does not quite "match up." When the particle was sitting still, these flows of energy matched up, but now

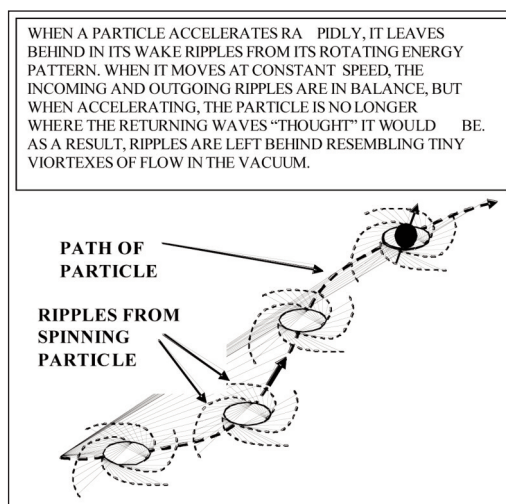

Figure 11. When a spinning particle accelerates or changes spin direction, this changes its radiation field of outgoing and incoming energy. This can be thought of as creating tiny whirlpools of vacuum energy which are no longer compensated. This gives rise to additional "twisting" or torsion in the space itself.

they no longer do. This means that the energy flow that would have been balanced is now not balanced. This leaves tiny whirlpools of swirling energy in the vacuum which are not absorbed and compensated as they would have been.

This is one way of understanding why torsion is created during irreversible processes. An irreversible process causes acceleration of particles. It pushes them out of the equilibrium position they would have been in. This gives rise to flows of energy in the vacuum that are not compensated. The swirls of energy which are left behind are part of the torsion which is created.

Torsion can also be viewed as a flux of left-handed and right-handed massless particles within the vacuum. The particles represent carriers of torsion. They are called “phitons” by some Russian theorists. The relative number of particles of each spin direction determines the rate of passage of time. Right handed spin S_R originates from local entropy increasing processes. It repels mass and carries right hand twist. Because of its action on matter, right handed spin is the likely source of “dark energy,” which repels matter. Likewise, left handed torsion, which attracts mass, is the likely source of “dark matter” which enhances gravitational attraction.

Regions of “dark energy” and “dark matter” are nothing more than regions of space

which are charged with right handed or left handed torsion, respectively. The torsion pattern creates a matrix within the vacuum. It carries holographic structural information which will influence the pattern of spark breakdown in Kirlian GDV photography. Just as the biophoton field creates a “hologram” inside the body to guide the DNA, the torsion field maintains this hologram outside the body and over long distances.

The rate of time passage depends on the difference between the right handed torsion waves and the left handed ones. If there are more right handed phitons the particle will be pushed into the future more rapidly. If there are more left handed phitons, the particle will be pushed toward the past, or

Figure 12. The Russian model of torsion sees the vacuum as filled with massless, spin one-half particles which carry the torsion force. According to Shipov these are called “phitons” and carry the left and right handed spins. In some Russian theories, the spin direction correlates with the direction of motion in time, with the right handed particles pushing forward in time. This is the basis for some devices, such as those of Chernobrov (Chernobrov, 2001), which claim to speed up or slow down time.

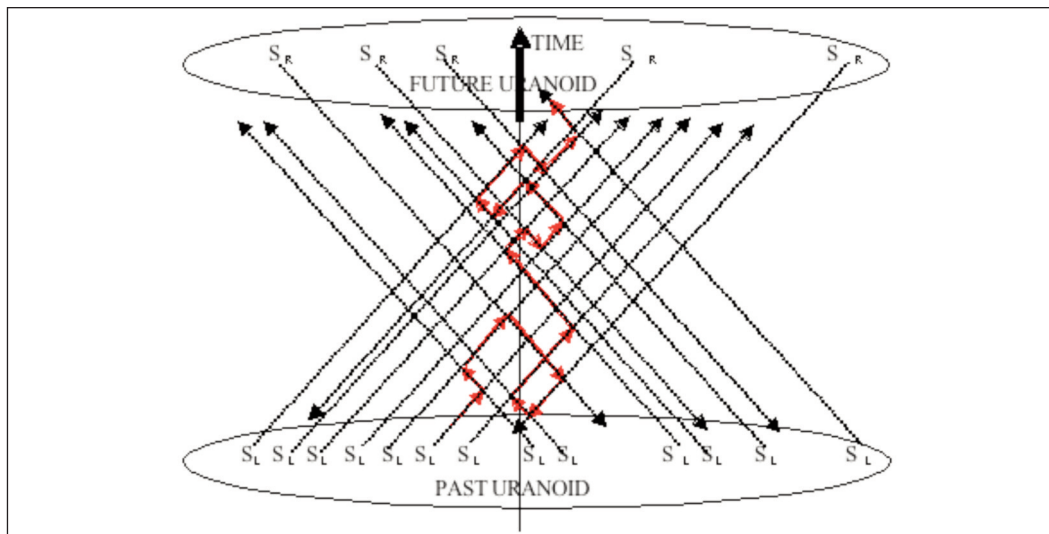

at least the rate at which it moves into the future will slow down.

On the average, the number of left and right handed torsion particles are very nearly in balance. There is only a slight preponderance of the right handed particles. Consequently an electron or other quantum particle will appear to do a random walk in space and time, with only a slight average drift toward the future.

When we say there is a right handed torsion wave present, it means an excess of right handed torsion, over and above the normal background. Such a wave implies there are more right handed photons than normal. It also implies that time will be pushed forward faster in that regime. By contrast, when we say there are more left handed photons, it means the excess of right vs left handed photons has been reduced. The particle will be pushed forward in time more slowly in such conditions.

Together the criss-crossing pattern of left and right handed torsion lines make up a sort of "fabric," pushing any particles forward and backward in time. It has been proposed by Russian theorist Akimov that this may be the fundamental fabric of space-time, forming the backdrop for all of the physics we observe. If this is true, then the more familiar quantities, such as the space-time metric described by Einstein, ride on top of this structure. If this is correct, then the curvature Einstein described can be explained in a more fundamental way by the density of left and right handed torsion. Here are some of the salient features of

torsion physics, according to Akimov (Akimov, 1995):

- i) Unlike electromagnetism, in torsion fields energy of the same polarity is attracted to itself and opposite polarities are repelled.
- ii) Since torsion fields are generated by classical spin, when a torsion field interacts with an object only its spin state will change.
- iii) Torsion travels through most physical media without loss.
- iv) The group velocity of torsion waves is reportedly more than a billion times greater than the speed of light.
- v) Since all known substances are made of physical particles which have spin, therefore all substances have patterns of spins, whether regular or random. The pattern is often connected to the chemical and physical activity of the substance. This pattern can be altered by a torsion field.
- vi) Torsion fields are endowed with memory. An object with a torsion field causes a polarization of the vacuum energy surrounding it. The spin can persist in an object for a time from seconds to months depending on whether the spin is stored in the electrons or the nucleus. Spin can even persist in space for a time after the initial object is removed.

THE GENERATION OF TORSION WAVES

One important generator of torsion is the changing of the spins of particles. Most important elementary particles, such as electrons, neutrons and protons, have spin which is built into their nature as quantum particles. They spin on an axis just like the earth spins around the north pole, or the way a child's top spins. When a particle's spin suddenly changes direction, the particle produces torsion waves (Shipov, 1993).

This is especially important in the case of electromagnetism. An electron has both electrical charge and spin. When it accelerates, or changes velocity, it produces an electromagnetic wave. But along with this acceleration there is also a change in its spin direction. This is built into the physics of the electron. This change of spin direction generates torsion waves. Therefore **electromagnetic waves are almost always accompanied by torsion waves.**

Dr. Gennady Shipov has worked out the predicted torsion radiation in the presence of electromagnetism, and has presented the equations in (Shipov, 1993, 2002). His equations are similar to conventional electromagnetism, but there is an extra term in the case when a spin flip occurs, or when the plane of motion of the orbit of a charge changes.

When a charge moves in a circular orbit, it is expected to create electromagnetic waves.

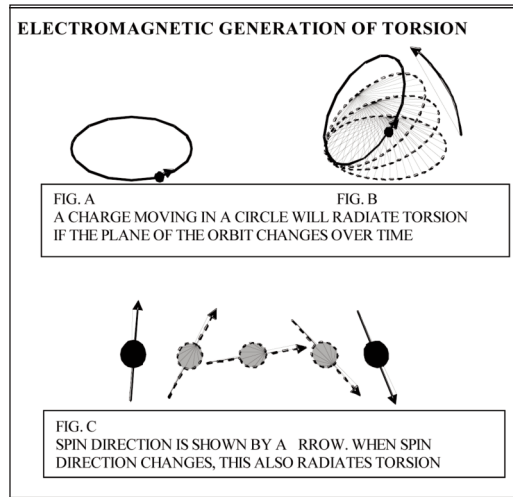

Figure 13. Torsion waves are created whenever the spin of a particle is changed. Torsion can be thought of as a “spin wave” which propagates through space. The top diagram in the figure depicts a circular orbit in which the plane of the orbit changes over time. Since the circular orbit defines a spin direction, perpendicular to the plane, it can also be represented as a change of spin direction with time.

Such a motion is illustrated in Figure 13A. But if the plane of the orbit changes over time, then it will also generate torsion waves, as illustrated in Figure 13B. Torsion waves can also be produced whenever the electron changes its spin direction, as shown in Figure 13C. Such a “spin flipping” also creates and radiates torsion waves.

Since it is the acceleration of the electron which produces both types of wave, **torsion waves will always be produced when electromagnetic waves are.** Consequently, most photons are accompanied by torsion waves. The light from the sun, for example, will naturally be accompanied by torsion waves.

SPIN AS A STORAGE MEDIUM FOR INFORMATION

In most normal materials the spins of its electrons and nuclei are distributed randomly. They point in many directions with no organization or order. Except for magnetic materials, where the spins are aligned by their mutual interaction, the spins of most materials have no pattern to them. **Torsion radiation is unique in that it can apply a pattern to their spins.** It can impose a new “structure” to a substance, where there was none before.

Spin information imprinted in the nucleus of atoms can last for years, potentially. The nucleus of an atom is much heavier than the electron, so it has more spin inertia. It takes more energy to change its spin. The nucleus sits in the center of the atom, far away from the effects of neighboring nuclei. It has a cushion provided by its electron cloud. Consequently, once the spin of the nucleus has been set in a certain way it will retain this direction for a long time, unless acted upon by torsion radiation.

This pattern of spins can encode information. It can later be detected by the torsion field of another individual. Typical solid objects contain many, many particles, on the order of a trillion trillion (that’s a trillion *times* a trillion) spins. Each one can theoretically hold one bit of information, making a small stone the potential reservoir for more information than all the computer hard drives on the planet!

Experiments indicate that patterns of spin can be transferred from one material to another. The recipient material often mimics the properties of the first. This has been tested in experiments transferring the properties of alcohol to water, for example. When the spin pattern of the water has been set to match that of the alcohol, it is said to also mimic the flavor and even, in mild form, the inebriating properties, although chemically it is still pure water! This process of transferring spin patterns appears to be the mechanism behind homeopathy.

Similarly, in psychic phenomena there is a process known as psychometry or “scrying.” It involves holding an object in one’s hand and deriving impressions about its owner, or about a person who has had long contact with the object. It is said that contact with the object “charges” it with information, and the psychic can read this information by holding the object.

Although long regarded with skepticism by scientists, this process also appears to be explainable based on spin patterns held in the object. It is based on two observations. First, objects can be charged with spin patterns by using a torsion field. Second, every human being produces his own torsion field, and this can be used to transfer a pattern to a material object, or to read a pattern stored in a material object. In the rest of this article we will explain how our personal torsion fields are created, and how they interact with consciousness so they can be “read” and consciously affected and controlled.

LEVELS OF TORSION EFFECTS

i) **Polarization Effects in the Vacuum:**

Relative density of left handed versus right handed torsion particles determine the “time density,” and the density of “dark energy” and “dark matter.” This is responsible for the presence of “yin” or “yang” energy, or in von Reichenbach’s terminology, negative and positive “od.”

ii) **Magnetic Moment Effects:** It is our proposal that an increase in right handed torsion affects the magnetic moment and spin of those electrons, leading to spontaneous magnetization of otherwise non-magnetic materials such as stainless steel, reported in Reich’s laboratory, and in the next chapter by Pavlita and others. Paramagnetic materials will attract and store such energy.

iii) **Precession Effects:** Through torsion waves, the actual phase of precessing quantum particles in an atom can have an effect, and can be “read” and “written.” In conventional quantum physics, the precession of phase has only been used for particles in strong magnetic fields, such as NMR. With torsion fields, each atom can be seen as a set of precession frequencies and phases, which act as a complex identification of the material. Such patterns of frequencies can be transferred to other materials, causing them to mimic certain properties of the first material. This is also the basis of the psychic process known as psychometry. Certain shapes such as pyramids and cones are optimum

for entraining spins into coherent precession, so geometry may play a role in the linking precession of many particles.

iv) **Long Range Coherence Effects:** When particles throughout a material precess in phase with one another, it gives rise to a special kind of torsion field. It is believed that this is the source for some long-range “entanglement” phenomena, such as those seen by Tiller when laboratories in different states showed entanglement (Tiller, 1997, 2001) and in Roger Taylor’s experiments described in Chapters 6 and 10, in which long range connection of “coherent” objects was detected between England and the United States. It is believed that such coherence effects can be thought of as mixing two or more parallel physical planes to create beat frequencies.

Because different chemical elements have different numbers of spins in their electrons as well as their protons and neutrons, each material has a unique spin signature. Techniques have been developed enabling this spin to be read, recorded and reproduced, according to some torsion scientists (Kronn, 2008).

THE ROLE OF BIOPHOTONS

The old picture of biology, prominent in the 1950’s, was based on chemistry. Life processes were explained in terms of complex organic molecules which bumped into each other, carrying out complicated

chemical reactions. When DNA was discovered it was believed that it would explain how the seemingly chaotic soup of molecules in the body was governed and organized to build cells and tissue, as well as living creatures. But there were still many mysteries.

How did the DNA in one part of the human body, for example, know that it was supposed to be building a foot, while the identical DNA in the head would know it is supposed to be making brain tissue? The control mechanism that governed this complicated building project was missing.

There are many components to this answer. Part became clear when it was learned that the DNA molecule can “express” itself in different ways, based on its interaction with its chromatin. In this way, different proteins needed in different organs can be produced as needed. This is part of the “specialization” and “differentiation” process. Another part of the answer is that all of these mechanisms respond to biophotons, which can, therefore, control these processes.

The other part of the answer is that the biophoton field is phase coherent and holographic. This means that its signals can be different in different parts of the body, depending on the position of the DNA in the hologram. Biophotons come in many frequencies, each one produced by some transition between states in DNA or other molecules. They form the signaling system enabling DNA to communicate with itself and with other molecules throughout the body. And even more remarkably, the biopho-

tons produced are coherent, meaning they have fixed phases just like light in a laser. This enables them to erect and maintain a hologram of light signals permeating the body. This forms a three-dimensional framework and pattern which enables all DNA to tell where it is in the overall blueprint, which in turn tells it whether it is supposed to be making brain tissue or a toenail!

Much of our modern knowledge of biophotons comes from the work of Dr. Fritz-Albert Popp and his associates. It began at the University of Marburg in 1972, and continues today at the International Institute of Biophysics (IIB) in Germany. Popp explored the hypothesis that biological regulation within the body was governed by photons, which control communication and regulation both inside the cell and between cells (Popp, 1994a). Today his discoveries are recognized for their far-reaching importance.

The discovery of biophotons has led to a new model of how the body works. The cells are seen as the primary building blocks. The machinery of each cell coordinates its activities internally and externally by exchanging biophotons with the other cells. Organization occurs cooperatively using a pattern supplied by the DNA, which sends and receives biophotons. According to biologist Dr. Bruce Lipton:

“As a cell biologist I can tell you that you are in truth a cooperative community of approximately 50 trillion single-celled citizens. Almost all of the cells that make up your body are amoeba-like, individual

organisms that have evolved a cooperative strategy for their mutual survival. Reduced to basic terms, human beings are simply the consequence of 'collective amoebic consciousness.' (Lipton, 2005)

In this picture, the biophoton serves as the “internet” which keeps the cells linked together and acting in unison. Without biophotons, the cells would act independently, and chaos would ensue. But biophotons do more than that. Their energy serves as a “catalyst,” in the chemical sense. It causes certain chemical reactions to occur, and provides the energy to trigger the reaction.

The mechanism by which biophotons interact grew out of discoveries by Frohlich (Frohlich, 1983) who realized that quantized packets of light could cause chemical and physical changes in molecules, and could be the key element in controlling complicated biological processes. DNA is the master molecule at creating and absorbing biophotons of many frequencies. Because of this DNA is able to “stage manage” the other molecules in the cell. It is this property, together with DNA’s storage of the genetic code within its base sequence, which enables it to do its work.

The chemical reactions which go on within a cell could never occur at the rate they do without help from biophotons. This occurs in several ways. The DNA molecule, and some others, are capable of applying forces to the other molecules in the cell. This enables them to apply a kind of “tractor beam” attracting the specific molecules they

need for a certain chemical interaction. If not for this, it would take a very long time for the right molecules to bump into each other in the cell. The active control of the biophotons greatly speeds up the reaction process.

The second role biophotons play is as a catalyst. They give an energetic boost to the interacting molecules. Many of the needed chemical reactions would not occur without this. Biophotons enormously speed up the reactions and make them more efficient. It has been estimated that without the biophotons, the cells would have to operate at much higher temperatures to have the reaction rate they do.

And the last role of the biophotons is as an energetic store. When the chemical reaction is finished, the biophotons are released and go back into storage in the form of molecular vibrations. Here they are kept until needed again, without losing energy or phase information. This is one of the secrets to how life processes are so efficient.

Popp estimates that most of this energy is stored within the DNA, which contributes more biophotons than all the other molecules combined. It also uses these to communicate with the other biomolecules such as enzymes, and with the numerous organelles within the cell, each of which has specialized functions. It communicates with the cell walls, which contain specialized gates which control the entry of nutrients and exit of waste from the cell. And the DNA couples to other DNA molecules in other nearby cells. This links the electro-

magnetic fields across many cells, creating a local “hologram” which serves as the blueprint for cell activity.

Even though the DNA of each cell seems to be independent, it is coupled to the DNA in the other cells via the biophotons which they exchange. For each biophoton emitted, there are billions that are stored in the vibrations of the DNA. These provide the phase reference which allows the light from each cell to keep its rhythm, to stay in step with other biophotons emitted by other cells.

The theory of “quantum coherence” developed by physicist Roy Glauber (Glauber, 1969) shows that this can be done even when the “laser” involves many modes, as long as they are coupled.

“The picture is of an immense super-orchestra with billions of instruments playing at many different frequencies over a range of seventy-two octaves. Each instrument can play its own unique songline, with maximum freedom, while staying in step with the entire orchestra. This is an analog for the way coherence and multiple frequencies play a role in the biological processes (Ho, 1998).”

It is this “quantum coherence” which has been shown to be at the root of the beat variability of a healthy heart, for example. It can be shown that healthy hearts have more variability in rhythm than unhealthy hearts. Many frequencies are involved but there is a “high degree of phase coherence” between the different rhythms.

The stored biophotons enable the body to operate at a high level of energy, and yet at the same time have a reservoir of energy on tap instantly. This enables the organism to react when needed. It is how we go so quickly from a resting state to a running state. It enabled us to survive the threats from predators when we lived in caves. Without this high concentration of stored, coherent photons inside the body, life would be impossible. We would be dead. Therefore **keeping most of the photons inside the body, and coherent, is essential for life.**

It is helpful to have a rough idea of the sizes of the various components involved. According to Popp, a cell is about 10^{-3} cm, or about 10 microns in diameter. A micron is a millionth of a meter, or a thousandth of a millimeter. The cell is filled with biophotons of different frequencies forming an “electromagnetic bath” of energy. Many chemical processes in the cell start when a molecule or group of molecules absorbs a photon from this reservoir. This raises the complex of molecules to a higher level, preparing it for a chemical reaction. This process is sketched in Figure 14.

Once the chemical reaction takes place, the excited complex of molecules gives back its biophoton to the “electromagnetic bath.” The average reaction time for a chemical reaction of this type is about a billionth of a second, or 10^{-9} seconds, so a single stored photon can trigger a billion reactions per second. Because the photons are continually returned to the bath, the cell does not need a large number of them. However,

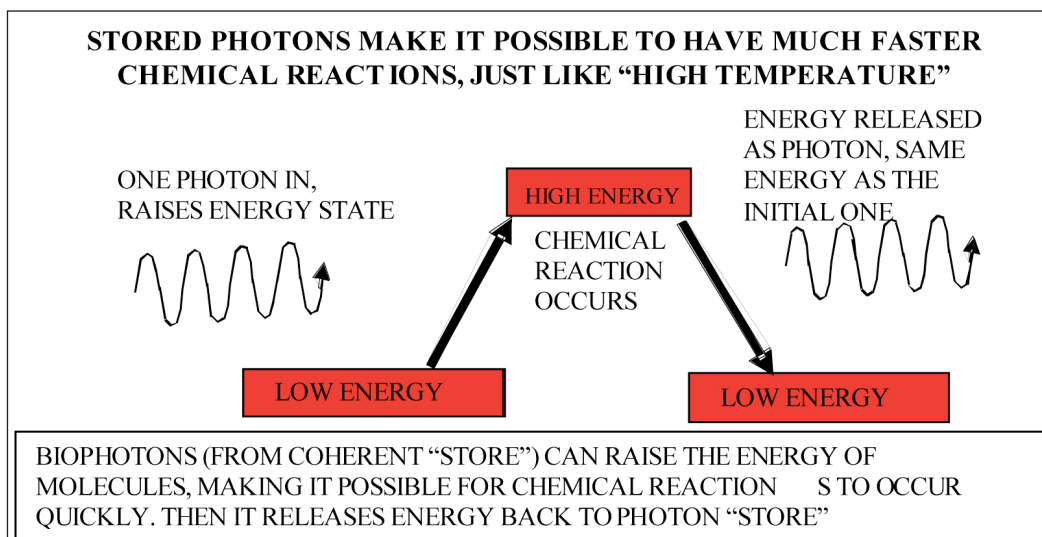

Figure 14. The role of the “biophoton store” to promote life processes. Many chemical reactions need an energy boost to occur at the needed rate within the body. Adding a biophoton of just the right energy acts like a catalyst, raising the energy of the molecules taking part in a reaction to just the right level so it increases the reaction rate. In many cases it results in large increases in reaction rate over that which would occur without any biophoton assist. Resonant structures within the cell enable these reactions to occur in such a way that the extra energy can be recovered after the reaction, and returned to the coherent store of biophotons.

compared to the number of photons which would be present in a non-living medium, there are many more photons found in the cell, between 10^{10} and 10^{40} times more. It has been estimated that, to achieve these reaction rates through conventional thermal means, would take a reaction temperature exceeding 3,000 degrees Centigrade. And such a temperature would completely destroy the organism!

The **coherence length** is a measure of how much correlation there is between photons in different parts of the body. Since a typical shift of cell energy (optical transition) takes about a billionth of a second, at the speed of light the photon will travel about 10

centimeters. This is Popp’s estimate for the typical biophoton coherence length. It is 10,000 time longer than a cell. This means that a photon crosses many cells, and implies that the DNA in many adjacent cells will be coupled to the same biophotons. This leads to the conclusion that the biophoton field is coherent over many cells. Over this distance at least, its phase is stable and can form interference patterns.

Popp carried out calculations (Popp, 1989) which concluded that biophotons are stored primarily in the DNA. In the body it holds between ten million and 100 billion (10^7 to 10^{11}) of them at any one time. It is so efficient at storing them that a photon will

vibrate more than a billion **billion** times (between 10^{18} to 10^{20} times) before its energy is lost.

Consequently, although only a few biophotons are emitted from the skin, there are many more stored within the body. The weak flow of biophotons which forms the images seen in the CCD cameras are merely the few which “got away.” The emission of biophotons out of the body does not seem to be an important process, except as an indicator of illness. There are so many photons stored within the cells that it is to be expected that a few escape. The storage of biophotons is surprisingly effective.

What enables the DNA to communicate over larger distances within the body? If the coherence length is only 10 centimeters, how is phase coherence maintained between the foot and the head? At the present time, there are several possible answers to this. One of these is the torsion field. Torsion is created along with biophotons, and they penetrate tissue more easily.

Perhaps the most important contribution is the acupuncture meridian system. It is known to carry coherent signals in at least the millimeter frequency range (10 GHz to 100 GHz), and these signals, because of their slower propagation speed in tissue, can carry fine scale spatial information, including holographic patterns of tissue and organs (Sit'ko, 1993, 1994a, 1994b; Shaduri, 2005a, 2005b) Through them, a biophoton signal can propagate to all parts of the body, maintaining phase reference so the resulting biohologram is coherent.

PHASE-CONJUGATE REFLECTIONS AND THE BIOHOLOGRAM

Given the large number of biophotons being created, what keeps all this energy inside the body? While some is stored in individual DNA molecules, the coherence length of 10 centimeters or more means that many biophotons propagate through the cells. Measurements with sensitive cameras show that only a very small number of these emerge from the skin, so most must be reflected by the tissue and kept inside the body. This reflection must be highly efficient to keep most of the biophoton energy inside. But there is a second requirement: the **biophotons must remain phase coherent inside the body after being reflected.**

If the skin and tissue acted like simple mirrors, then each time a biophoton was reflected it would bounce back at a different angle, creating a chaotic mess of electromagnetic energy within the organism. It would not be possible to create or maintain a coherent holographic pattern of energy. This is illustrated in Figure 15.

The first panel on the left in Figure 16 illustrates a wave which undergoes specular, mirror-type reflection at a boundary. It represents what would happen if a biophoton were internally reflected inside the body. When such a wave encounters a reflection, it goes off at a different angle, and does not combine with the initial wave. It will not create a standing wave pattern. This results in a chaotic jumble of waves inside the body.

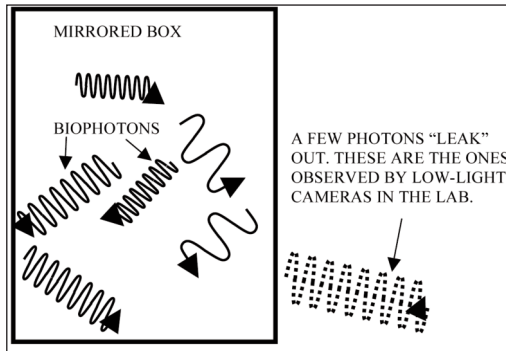

Figure 15. For the survival of the organism, it must maintain its level of biophoton energy at a high level. This requires keeping the biophotons inside the body. If this were done by absorbing them at the skin, the biophoton reservoir would drop to near zero in a fraction of a second. If the energy were reflected at the skin by conventional mirrors, it would keep it inside the body, but its angle of reflection would be different from its angle of incidence. Furthermore it would change each time a person changed his posture! Conventional mirrors would cause the waves to lose their coherence so they would not form a hologram.

The resulting energy pattern would be unsuitable to maintain a three-dimensional blueprint.

By contrast, the right hand panel in Figure 16 shows what happens when a photon is reflected in a time-reversed manner. This is what happens when the boundary reflects by “phase conjugation.” It creates a photon which is the **time reversed copy** of the incident photon. Then it retraces its initial path, and will add to the energy of the incident photon, producing a **standing wave**. This is a requirement for the biophoton ensemble to create a **stable hologram**.

The resulting orderly pattern of biophoton standing waves will create stable patterns of

energy inside the body. When reflection and containment are due to phase-conjugate reflection, the biophotons inside the body form well-defined regular standing waves, which create a three-dimensional hologram which serves as a guide for the structure of the body, organs, tissue, nerves, muscles, skin, etc. This is indicated schematically in the symmetry and regular pattern of waves inside the body in Figure 17.

Dr. Peter Gariaev (Gariaev, 2002, 2007) has proposed that living systems used this technique to solve this problem in exactly this way. He proposes that their chromosomes (DNA) reflect biophotons by “phase conjugate reflection.”

This means that when a biophoton is reflected by the DNA in the tissue, it does

Figure 16. When a biophoton is contained inside the body by conventional reflection, it creates a pattern of waves which lose coherence, and destroys any holographic pattern. However, when the biophotons are reflected by phase-conjugation, as Gariaev proposes, the pattern of a coherent hologram is preserved. This explains how the body is able to maintain a stable template of waves so efficiently, without losing energy.

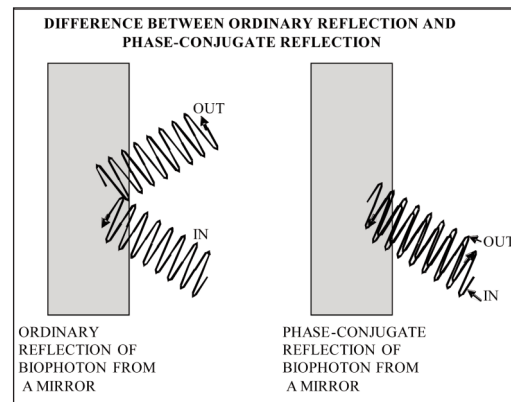

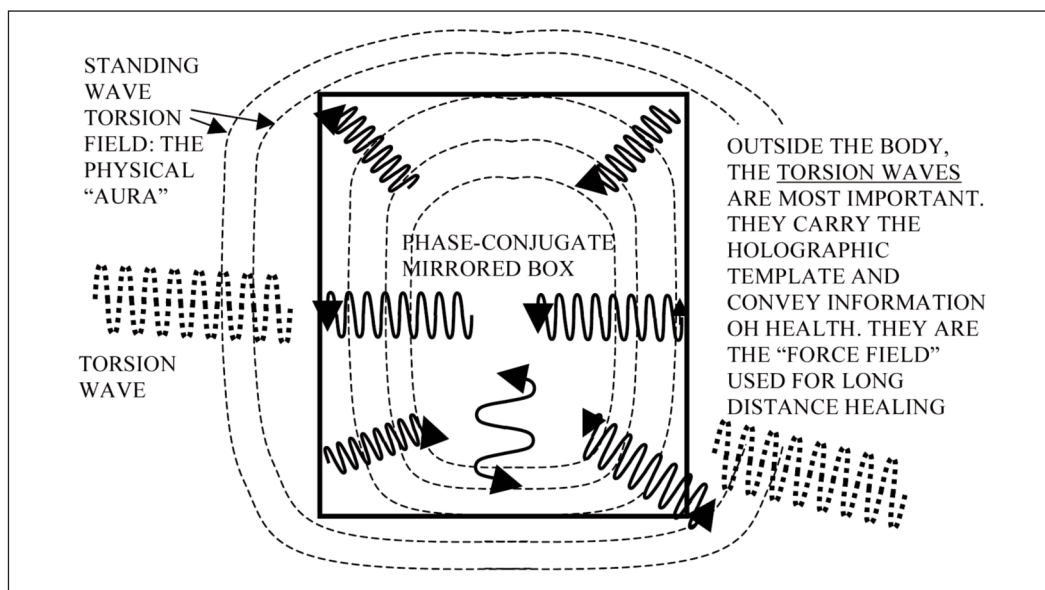

Figure 17. If the reflections at the boundary of the container are phase-conjugate, then the phase and direction will be retained by the outgoing waves.. According to Gariaev (Gariaev, 2002, 2007), the chromosomes (DNA) generate such reflections. Many different frequencies are present. This makes it possible to create coherent "standing waves" inside the box, which preserves the three-dimensional holographic of the body which serves as a template for growth.

so in a phase conjugate manner. A time reversed wave is created. It retraces the same path it followed coming in. This leads to an orderly pattern of energy, as illustrated in Figure 17.

A system of biophotons in a container of this type will preserve its phase and create a stable hologram. This is one of the secrets to how the biophoton system generates a holographic template of the body. The resulting shape of the hologram actually contains the form of the body and its organs. It creates a three-dimensional blueprint of the internal structure, which can be received and read by any DNA in its energy field.

When the biophotons are internally reflected inside the body, in this way outgoing electromagnetic radiation which might escape the body is canceled. This keeps the biophotons inside the organism, to a very good approximation. It also keeps the energy inside. BUT, there is something that is left over. Something escapes when the photons cancel each other. It is the torsion wave, illustrated in Figure 18 as the dashed line. It is not canceled and plays an important role outside the body.

Therefore even though the biophoton density is low outside the body, the torsion field is not. It is not canceled in the same way, and can be strong outside the body. We propose that it is this pattern of torsion

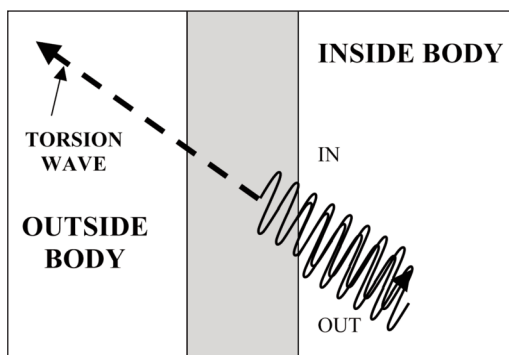

Figure 18. When biophotons are reflected in a phase conjugate matter inside the body, the electromagnetic field outside the body is cancelled to a good accuracy. However, something does remain outside the body: the torsion field. It carries information about the biophotons, while carrying very little energy. This field makes up much of the "aura."

waves which creates the aura, and accounts for long distance healing. Because torsion waves are coupled to the biophoton field, they carry the same holographic information, and the same frequencies. It is the **holographic pattern of torsion energy** which makes up the aura.

In Figure 19 we represent schematically the combined holograms created by the biophoton field and the torsion field. The holographic structure created by the biophotons includes the physical organs, nerves, blood vessels, tissue, bones, and all other components of the internal physical anatomy. The holographic structure created by the torsion field includes all the structures considered to be "subtle energy": the various layers of the aura, the chakras, and various "nadis" or channels and energetic components which exist in the

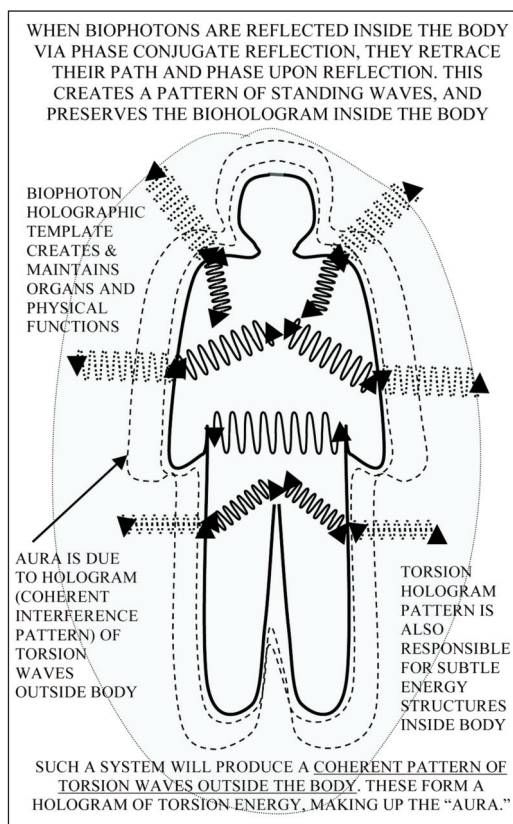

Figure 19. An emerging new understanding of the aura is based on the holographic pattern of biophotons inside the body. Because containment is accomplished with phase-conjugate reflection, this results in a standing wave pattern of biophotons inside the body which serve as a blueprint for physiology. However, outside the body the biophoton field is extremely weak. Otherwise energy loss would be tremendous and harmful to the body. When the biophotons are phase-conjugate reflected, they generate torsion waves which propagate beyond the body, and form a holographic standing wave pattern around the body. This field interacts primarily with spin. It contains very little or no energy, and maintains the holographic information and connection to "higher planes." It is the torsion field which is the physical basis for the aura.

subtle energy structure, both inside and outside the body. The acupuncture meridian system is part of the physical body, but since it also carries subtle energy, it appears in both patterns.

When we combine the holographic, coherent fields of the biophotons which exist primarily inside the body, and the holographic field of the torsion, which exists both inside and outside, we arrive at a holographic, 3-dimensional image which shows the blueprint of the physical organs and tissues as well as the subtle energy structures, the layers of the aura and the chakras. This is depicted schematically in Figure 20.

TORSION FIELD AND LONG DISTANCE HEALING

One of the great challenges faced by scientists is how to explain the non-local effects of consciousness. How is it that a Qigong healer can affect a patient, or an experiment, thousands of miles away? The *Intention Experiment* (McTaggart, 2007) is a perfect example. The biophoton output of a leaf showed that it received a signal from thousands of miles away. But what was the form of the signal?

Some scientists today try to explain these effects as due to biophotons or perhaps “entangled biophotons.” Such a model may seem plausible when the healer and patient are near each other. But in many experiments, as we described in Volume II, highly

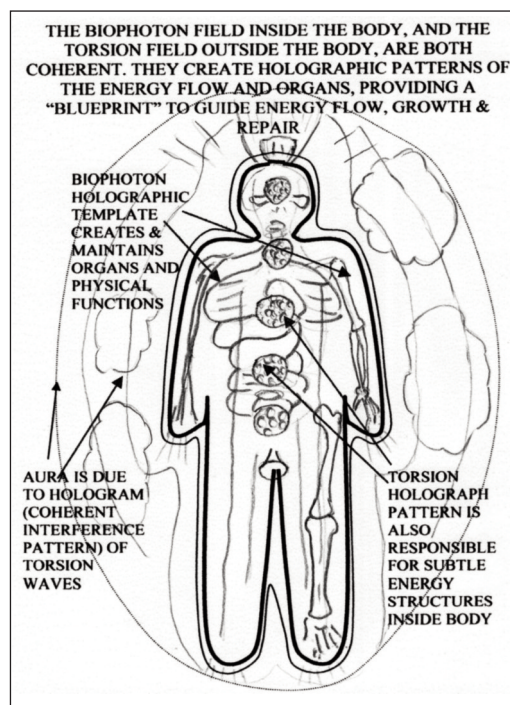

Figure 20. The biophoton fields inside the body, and the torsion fields outside the body, are both coherent. This means that they each have stable phases. In this way, they create interference patterns, otherwise known as holograms. These patterns are three dimensional or higher. As we saw in Chapter 4, the biophotons in the acupuncture meridian create holograms which are patterns for organs. They carry instructions which are read by the DNA, enabling it to create and maintain the complex spatial structure of the body. Likewise, both inside and outside the body, the torsion fields create holographic patterns, too. These are responsible for the subtle energy structures of the body, the chakras, certain aspects of the acupuncture system, the subtle energy flow within the body, and the layers of the aura.

successful results are obtained when the patient is thousands of miles from the healer. Simple energy calculations show that it is impossible to affect the patient using biophotons under such conditions. Biophotons are weak to start with, and after traveling thousands of miles they would be too weak to be detected.

A normal person emits at most a few hundred biophotons per second per square centimeter. The skin presents an area of maybe a square meter at most, which is 10,000 square centimeters, so a potential healer at most emits $200 \times 10,000 = 2$ million biophotons per second. But at a distance of 1,000 miles, where many successful healing experiments have been done, the energy diminishes as the square of the distance. This implies that the patient will receive only about one biophoton per second over his entire body. And this overlooks that clothing will absorb most of the energy, and the atmosphere, clouds, the curvature of the earth, and buildings will absorb the rest. It overlooks the healing experiments done in Faraday cages, which completely rule out the biophoton and entangled biophoton theories. It overlooks the fact that, in healing experiments, **the signal penetrates all barriers, and is just as strong a thousand miles away as it is one foot from the healer.** So, for many reasons, the theory that healing is accomplished by biophoton emission just doesn't fit the facts.

The related idea is that the biophotons of the healer somehow become quantum entangled with the biophotons of the

patient. The major problem with this idea is that it is difficult and delicate to produce a quantum state with entangled photons. It usually requires the photons to be in contact, to be co-located at some point, or for the product of the amplitudes of the two states to be high at some point along the trajectory. This will imply that they have a high signal to noise ratio somewhere along the path, too.

In remote healing, the healer starts out far away from the client, with perhaps little information about the target other than a name and address. Getting the biophotons of the healer and patient to become entangled under such high noise conditions is very unlikely. The science of quantum teleportation, using entangled photons to send information, is a science under active development, and has shown that entangled photons under highly controlled conditions may lead to advances in communication. But all of these experiments involve precise wave guides, stabilized optical benches, quantum repeaters along fibre optic cables to keep up the signal strength, and conditions of very high signal-to-noise ratios.

Energy healing in the real world has just the opposite conditions: very high noise, unstable propagation conditions and very weak signals. This is not a promising environment to attempt to entangle photons. For these reasons, we conclude that neither direct biophotons nor "entangled photons" are likely to explain remote healing experiments, nor the wide variety of other long distance anomalous communications results, including the ESP,

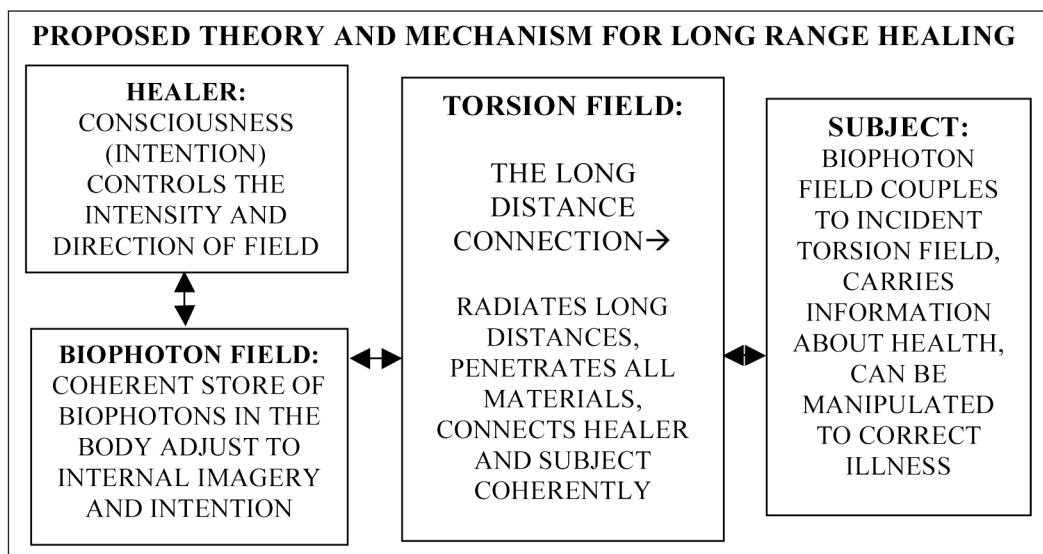

Figure 21. Schematic explanation of the mechanism for long range healing. At both the healer and the recipient there are internal biophotons which maintain life processes. Outside the body these are negligible, but the torsion fields corresponding to each biophoton ensemble is significant. This makes up their auras. The torsion field carries little or no energy. By adjusting his torsion field, the healer can project it to couple to the torsion field of the patient. When they become resonant he can use his field to modify the torsion field of the patient, because the two fields interact non-linearly. In this way new "information" and patterns can be transferred from the healer to the patient using a negligible amount of energy.

PK and remote viewing experiments described in Volume I.

The model we propose here is different from either of these. It is compatible with all observed facts, and is consistent with how healers describe the process. We propose that the **long range interaction between healer and healee is not based on biophotons but on torsion waves**. Inside the body there is a high density of biophotons, and these create and maintain the field of torsion waves around the body.

Torsion waves can penetrate barriers that would stop photons. This, too, is consistent with experiments in shielded rooms. Torsion

waves have many of the characteristics needed to explain remote healing, PK, ESP and other "anomalous" effects. Our model proposes that the biophoton field around the body serves as an interface between internal physical processes involving DNA, on the one hand, and external, long range, effects involving torsion waves. The biophoton field in the body will generate the torsion waves, but it is the torsion waves, not the biophotons, which travel from the healer to the patient, especially in the case of long distance experiments.

When the torsion waves arrive at the patient, they interact with his torsion field, which

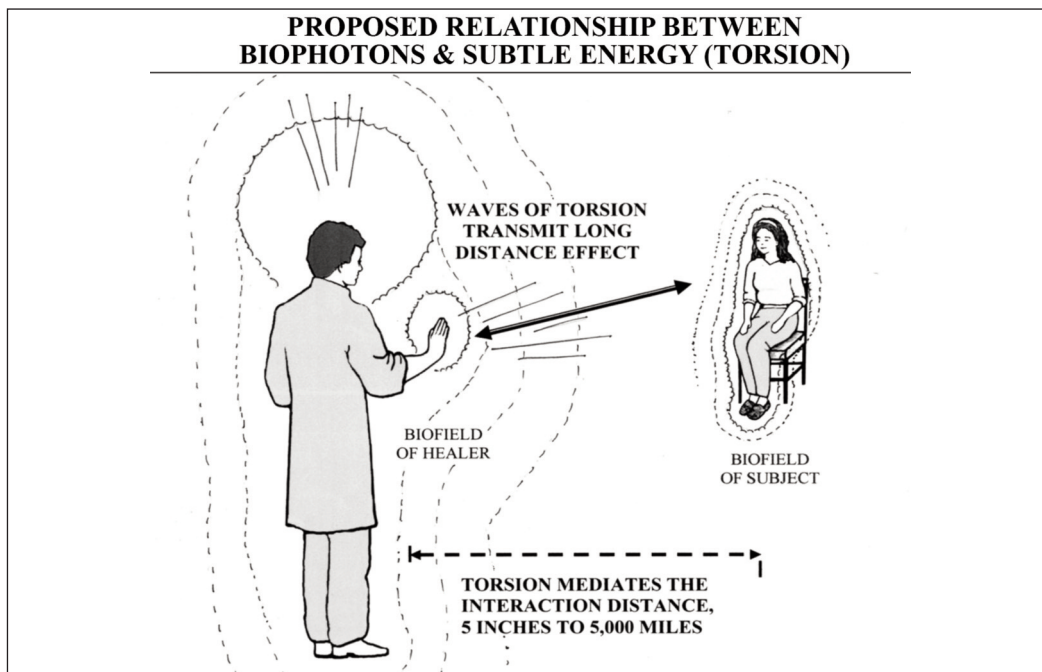

Figure 22. This sketch illustrates our proposal for the relationship between the biophoton field and the subtle energy or “torsion” field, as developed by Shipov and described in Chapter 7. Around the body and for a few inches away from it there is a coherent field of biophotons, not just the ones which are emitted every second, but billions of times more photons which are stored in the body. The healer projects his “energy” by setting up coherent vibrations of the biophotons in his body, which are controlled and coordinated by his intention and visualization. The biophoton field near the healer creates a field of torsion waves (subtle energy, spin waves) which propagate and couple to the target individual.

then transfers pattern information to his biophoton field. Just as with the healer, the internal biophoton field of the patient has a high energy density, because most biophotons are stored inside the body. This means there will be a strong interaction between the incoming torsion field and the biophoton field in the patient. Because the healing process often involves two-way exchange of information, the healer can adjust his transmitted torsion wave to best resonate with the patient. The torsion waves will modify this biophoton field as directed to accomplish healing.

Torsion waves also interact directly with matter, since they couple strongly to spin, so they can affect inanimate objects as well. This explains how torsion waves affect the crystalline structure and metallurgy of substances, as we described in Volume II. It also explains how Random Event Generators, REGs, can be affected even at great distances.

This model resolves several issues which plague the direct biophoton model and the “entangled biophoton” model. Biophotons are light and carry energy. **In order to generate enough of them to travel to a target 6,000 miles away, and have enough**

energy left to affect a patient, requires a prohibitive amount of energy. If a healer is able to accomplish healing in the laboratory a meter away from a patient, then it will take about 10^{14} times, or **100,000 BILLION** times MORE energy to heal at a distance of 6,000 miles. He would light up like a lighthouse, blinding all those around him with his biophoton output!

Experiments with remote healers indicate that they expend about the **same amount of energy** for nearby as for distant targets. Therefore biophotons are ruled out as the primary means of distant healing. Using biophotons would require an increase of biophoton output by a factor of billions or more. The beauty of torsion waves is that they do not carry energy, according to Shipov. Therefore power requirements are not an issue. This is one of many reasons why the torsion wave model is more attractive than the biophoton or “entangled biophoton” models in explaining long range healing.

HOLOGRAPHIC FOCUS

This model for long distance healing explains many things. However, it does not explain how a healer is able to pick out a single person 10,000 miles away, and prevent his energy from being diffused among millions of people. There is another factor. The healer and the “healee” are usually in energetic contact, despite the great distances. Their brain waves and other vital frequencies often become synchronized. The healer “sees the body” before him as a

hologram, in many cases. And the healee can often feel the energy from the healer. This is a specific and targeted process. These feelings are not reported by the millions of people in range of the healer, but only by a single individual.

To explain this type of unique focus, we must resort to a key principle of the Synchronized Universe Model: that **interactions via torsion are holographic in 4 dimensions**. After all, research has shown that torsion waves DO travel forward and backward in time. Therefore the healer’s torsion waves are coupled to the distant matter in both the past and the future. While backward traveling photons may be questioned, there is solid evidence from the telescope measurements (see Figure 8 and 9) that torsion waves travel in both directions in time. This implies that a healer sending out coherent torsion waves in both time directions can arrange for them to **focus coherently at a unique point in space and time**. In this way, they can be focused much more precisely than light. By focusing in this way, all the emitted torsion is preserved and refocused at the target. Distance is not a limitation at all, and barriers will have no effect.

This process can be illustrated in Figure 23, which is based on the SUM model described in Volume I. There are **two holographic gratings**, one arising from matter in the past, and one from matter in the future. It is the combined interference of these two patterns which creates the 4-D hologram. In this picture it is the distant matter of space, in **both the past and the**

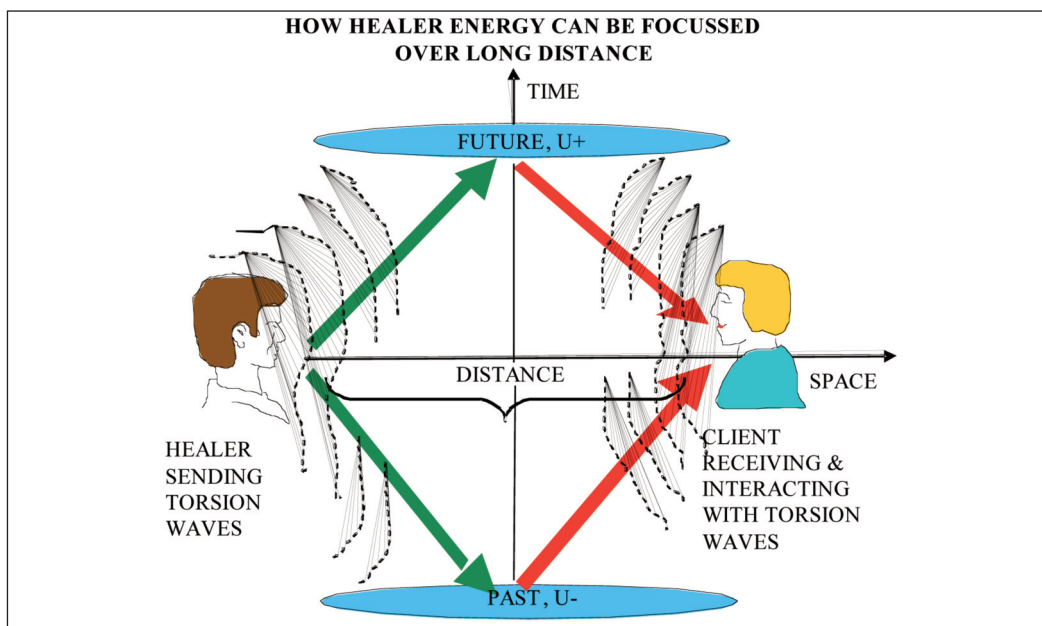

Figure 23. This is an illustration of how the 4-D hologram of the Synchronized Universe model explains long distance healing. The energy transmitted can be either light or torsion waves, although it appears more likely to be torsion. This requires much less energy and is consistent with the Russian research. The waves are sent out by the healer into both the past and the future. They reflect off the distant matter and then travel in the opposite time direction, converging at the client. Since direction of time does not matter, waves are also transmitted and reflected from the client back to the healer. This enables him to receive a holographic image of the client enabling him to analyze and detect changes.

future, which forms the holographic pattern. The torsion field which results at the focal point, the helee, is based on the pattern sent by the healer. It interacts with the torsion field surrounding the helee, and changes it. These changes then affect the biophoton pattern within the helee, and in this way directly affect the DNA. All of these changes lead to corrections of various “errors” in the energetic pattern of the helee, and in this way removes the illness by correcting the pattern.

This model was presented in Volume I, but there it was assumed that the energy

forming the hologram was made of “virtual photons.” In light of the Russian research, it appears more likely that it is the torsion field which mediates the information transfer between healer and helee. This same interaction also describes so-called “psychic” phenomena such as ESP and remote viewing, which it also explains more successfully than other models.

SUMMARY

1. Biophotons synchronize the DNA in the body. This creates a coherent field in

the living organism which enables it to behave as a “phased array,” directing energy at the distant matter and creating holograms. Without this level of phase synchronization, the radiation from each cell would be independent, and it would be impossible to create a directed beam of torsion energy.

2. Biophotons carry torsion information. The electromagnetic energy may be stopped by barriers, but the torsion signal penetrates it.
3. Biophotons play an essential role in communication and coordination of the cells. Without it the cells would behave autonomously, each acting on its own. This has been observed during the decay process of the body after death. Therefore the biophoton matrix is an essential component of “life” on the scale of plants and animals, i.e. multi-celled animals.
4. Beyond the body the biophoton field is essentially zero. In this region torsion waves create the persistent fields around the body known as the aura and the chakras. Since these are coupled to the biophoton field they contain all relevant health information and can be “read” by intuitive healers.
5. Healers use their own torsion field to interact with that of the “healee” to detect and read the field and to alter it.
6. Long distance energy healing is accomplished by establishing a “4-D” holographic connection between the healer and healee. This is done by sending torsion waves into both the past and the future, where they reflect and recombine coherently at another location in space and time. This is the

primary method by which consciousness can interact with distant locations in space and time, carrying out energy healing and other distant phenomena such as remote viewing.

The new science of biophotons and torsion fields provides a bridge between two views of life. It begins with the old twentieth century view of man as a chemical machine, a “meat engine.” Clearly this describes some of the aspects of the human body. But it does not explain how growth or metabolism is governed nor how life processes are so efficient.

The new paradigm involves DNA as the source of biophotons, governing cellular machinery, and generating as well as reading electromagnetic signals which also govern its behavior. The coherent biophoton field forms a hologram throughout the body, maintained in part by signals carried through the acupuncture meridian system. In this way each DNA molecule knows where it fits in the overall blueprint, and this governs cellular differentiation.

And with the creation of each biophoton there is also a torsion wave. Although the biophotons carry electromagnetic energy and are contained mostly within the body, **torsion waves easily penetrate tissue and form the primary holographic pattern outside the body. This includes the subtle structure of the aura and chakras, and also the long range signals used in distance energy healing.**

The torsion field has been shown to couple to consciousness. It is affected by consciousness and in turn has an influence on it. It is a higher dimensional field, in the sense that it describes additional degrees of freedom which are absent in Western science today. The ability of space to carry a twist, and the importance of spin interactions which have been overlooked until now, introduce important new physical effects. The ability of torsion fields, which obey Yang-Mills gauge equations, to alter the rate of time and to produce stable energy forms without the need for matter, means that these fields can explain many kinds of "spiritual" phenomena ignored so far by mainstream physics. Torsion appears to be the missing ingredient which makes it possible to develop a true science of consciousness and understand the nature of life. Hence it may truly be called the "life force."

• • •

CORRESPONDENCE:

Claude Swanson • claudv_swanson@yahoo.com

REFERENCES & NOTES

1. Adamenko, V. G., "Is a Confrontation Between Parapsychology and Psychotronics Really Necessary?," *Seventh International Conference on Psychotronic Research*, Proceedings, Dec. 2-5 (1988)
2. Adamenko, Victor G., *The Problem of Time and Psi*, preprint (1989)
3. Akimov, A. E., Tarasenko, V.Y., "Models of polarized states of the physical vacuum and torsion fields," *Soviet Physics J.*, No.3, pp. 214-222, (1992)
4. Akimov, A.E. and Shipov, G.I., "Torsion Fields and Their Experimental Manifestations," *International Institute for Theoretical and*

- Applied Physics*, Preprint 4a, Russian Academy of Natural Sciences, Moscow (1995), <http://www.binet.lv/firms/project/Russian/torsion.htm> (1995)
5. Akimov, A.E., "Heuristic Discussion of the Problem of Finding Long-Range Interactions. EGS Concepts," English translation in *Journal of New Energy*, Vol. 2, No. 3-4, Fall-Winter (1997)
 6. Allais, Maurice F.C., *Comptes Rendu Academie des Sciences*, Vol. 245, p. 1697 (1957a)
 7. Allais, Maurice F.C., *Comptes Rendu Academie des Sciences*, Vol. 245, p. 1875 (1957b)
 8. Allais, Maurice F.C., *Comptes Rendu Academie des Sciences*, Vol. 245, p. 2001 (1957c)
 9. Allais, Maurice F.C., *Comptes Rendu Academie des Sciences*, Vol. 244, p. 2469 (1957d)
 10. Allais, Maurice F.C., *Comptes Rendu Academie des Sciences*, Vol. 245, p. 2467 (1957e)
 11. Allais, Maurice F.C., *Comptes Rendu Academie des Sciences*, Vol. 245, p. 2170 (1957f)
 12. Allais, Maurice F.C., "Should the Laws of Gravitation be Reconsidered? Part I- Abnormalities in the Motion of a Paraconical Pendulum on an Anisotropic Support", *Aero/Space Engineering*, September (1959a)
 13. Allais, Maurice F.C., "Should the Laws of Gravitation be Reconsidered? Part II, *Aero/Space Engineering*, October (1959b)
 14. Chernobrov, Vadim A., *New Energy Technologies*, p 52, July-August (2001)
 15. Dubrov, A. P., *Biogravitation*, presented at 1st Conference on Psychotronic Research, Prague (1973)
 16. Dubrov, A.P., *The Geomagnetic Field and Life*, Plenum Press, New York (1977)
 17. Evans, Myron, "A Generally Covariant Field Equation for Gravitation and Electromagnetism, Institute for Advanced Study," Alpha Foundation (2003)
 18. Frohlich, H., *Intern. J. Quant. Chemistry* Vol. 2, pp. 641-649 (1968)
 19. Frohlich, H., "The Biological Effects of Microwaves and Related Questions," *Advances in Electronics and Electron Physics*, Vol. 53, pp. 85-152, Academic Press (1980)
 20. Frohlich, H. in *Advances in Electronics and Electron Physics*, Academic Press, pp. 85-152 (1980)
 21. Frohlich, H., and Kremer, F., *Coherent Excitations in Biological Systems*, Springer-Verlag, Berlin (1983)

22. Frohlich, H., "Coherence in Biology," in *Coherent Excitations in Biological Systems*, Springer Verlag, Berlin-Heidelberg (1983)
23. Gariaev, Peter, "The DNA Phantom Effect: Direct Measurement of a New Field in the Vacuum Substructure," <http://homepages.ihug.co.nz/~sai/DNAPhantom.htm> (2002)
24. Gariaev, Peter P., Birshtein, Boris I., Iarochenko, Alexander M., Marcer, Peter J., Tertishny, George G., Leonova, Katherine A., and Kaempfer, Uwe, "The DNA-Wave Biocomputer," ON THE WEB (2007)
25. Glauber, R.J., "Coherence and Quantum Detection," in *Quantum Optics* (R.J.Glauber, Ed.) Academic Press, New York (1969)
26. Hammond, Richard T., "Spin Gravity," *General Relativity and Gravitation*, Vol. 31, No. 2 (1999)
27. Ho, Mae-Wan, "What is (Schroedinger's) Negentropy?" *Modern Trends in BioThermoKinetics*, Vol. 3, pp. 50-61 (1994)
28. Ho, Mae-Wan, Ph.D., *The Rainbow and the Worm – The Physics of Organisms*, (second edition) World Scientific Publishing Company Pte. Ltd., Singapore (1998)
29. Ho, Mae-Wan, Ph.D., and Knight, David P., "The Acupuncture System and the Liquid Crystalline Collagen Fibres of the Connective Tissues-Liquid Crystal Meridians," *American Journal of Complementary Medicine* (in press), Institute of Science in Society (2003), <http://www.i-sis.org.uk>
30. Jones, Joie P., "The Characterization of Acupuncture Points Using fMRI and Quantitative Ultrasonic Methods," *21st Annual Meeting of the Society for Scientific Exploration*, May 29-31, 2002, University of Virginia, Charlottesville, Virginia (2002)
31. Jones, J.P., and Bae, Y.K., "Ultrasonic Visualization and Stimulation of Classical Oriental Acupuncture Points," *Journal of Medical Acupuncture*, Vol. 15, No. 2, pp. 24-27, January (2004a)
32. Korotaev, S. M., "Logic of Causal Mechanics," in Levich (1996).
33. Kozyrev, N.A., "Causal or Nonsymmetric Mechanics in a Linear Approximation," Pulkovo (1958)
34. Kozyrev, N. A., "Possibility of Experimental Study of the Properties of Time," *JPRS*: 45238, translation, U.S. Department of Commerce, from Russian, Pulkovo, O VOZMOZHNOСТИ EKSPERIMENTAL'NOGO ISSLEDOVANIYA SVOYSTV VREMENI, September, pp. 1-49 (1967)
35. Kozyrev, N.A., "The Origin of Stellar Energy on the Basis of the Analysis of Observational Data," Academy of Sciences of Armenia, *Journal of Astrophysics*, Vol. 12, No. 2, Erevan (1976)
36. Kozyrev, N. A., "Time as a Physical Phenomenon," in *Modelirovaniye i Prognozirovaniye v Biologii* (Modeling and Forecasting in Bioecology), Riga, pp. 59-72 [in Russian] (1982)
37. Kozyrev, N.A., *Izbrannyye Trudy* ("Selected Works") Leningrad State University (LGU), [in Russian] (1991)
38. Kronn, Yuri, "Chi, The Missing Link," http://www.energytoolsint.com/lecture/chi_missing_link.htm (2008)
39. LaMothe, John D., *Controlled Offensive Behavior-USSR*, Defense Intelligence Agency Task No. T72-01-14 (ST-CS-01-169-172), July 1972, p. 27 (1972)
40. Lavrentiev, M.M. (Academician), Gusev, V.A., Eganova, I.A., Lutset, M.K., and Fominykh, S.F., "Detection of the True Position of the Sun," *Sov. Phys. Dokl.* Vol. 35(11), November 1990 (translated from *Dokl. Akad.Nauk SSSR*, 315, 368-370, November (1990)
41. Lavrentiev, M.M. (Academician), Eganova, I.A., Lutset, M. K., and Fominykh, S.F., "Detection of the Reaction of Matter to an External Irreversible Process," *Sov. Phys. Dokl.* Vol. 36(3), March 1991 (translated from *Dokl. Akad.Nauk SSSR*, 3317, 635-635, March (1991)
42. Levich, A. P., "A Substantial Interpretation of N.A. Kozyrev's Conception of Time," pp. 1-42, in *On the Way to Understanding the time Phenomenon*, World Scientific, Singapore (1996)
43. Lipton, Bruce, *The Biology of Belief*, Mountain of Love/Elite Books, Santa Rosa, California (2005)
44. McTaggart, *The Intention Experiment*, Free Press, a Division of Simon & Schuster, New York (2007)
45. Yu.V.Nachalov and E.A.Parkhomov, "Experimental Detection of the Torsion Field,"

- <http://www.amasci.com/freenrg/tors/doc15.html>
(2000)
46. Yu.V.Nachalov, "Theoretical Basics of Experimental Phenomena,
<http://www.amasci.com/freenrg/tors/tors3.html>
(2003)
 47. Yu. V. Nachalov, and A.N.Sokolov, "Experimental Investigation of New Long Range Actions – Analytical Review,"
<http://amasci.com/freenrg/tors/doc17.html>
(2004)
 48. Ostrander, Sheila and Schroeder, Lynn, *Psychic Discoveries Behind the Iron Curtain*, Bantam Books, New York, 1970.
 49. Ostrander, Sheila and Schroeder, Lynn, *Psychic Discoveries*, Marlowe and Company, New York (1997)
 50. Panov, Vyacheslav F.; Kichigin, Vladimir I.; Khaldeev, Gennady V.; Klyuev, Andrei V.; Testov, Boris V.; Yushkova, Tatyana A.; and Yushkov, Vladimir V., "Torsion Fields and Experiments," *Journal of New Energy*, Vol. 2, Nos. 3-4, Fall-Winter (1997)
 51. Popp, E.A., "Photon Storage in Biological Systems, " in *Electromagnetic Bioinformation*, Proceedings of the Symposium, Marburg, September 5, 1977 (Munchen-wien-Baltimore (1979)
 52. Popp, F. A., Ruth, B., Bahr, W., Bohm, J., Grass, P., Grolig, G, Rattemeyer, M. Schmidt, H.G., and Wulle, P., "Emission of Visible and Ultraviolet Radiation by Active Biological Systems," *Collective Phenomena*, Vol. 3, pp. 187-214 (1981)
 53. Popp, E.A., ed., *Electromagnetic Bioinformation*, Urban & Schwartzberg, Munchen-Wien-Baltimore (1989)
 54. Popp, F.A., et al., *Recent Advances in Biophoton Research and Its Applications*, eds. F.A.Popp et al, World Scientific, Singapore (1992)
 55. Popp, F.A., and Li, K.H., "Hyperbolic Relaxation as a Sufficient Condition of a Fully Coherent Ergodic Field," *Int. J. Theor. Phys.*, Vol. 32, pp. 1573-1583 (1993)
 56. Popp, F.A., Chang, J.J., Gu, Q., and Ho, M.W., "Nonsubstantial biocommunication in terms of Dicke's theory," in *Bioelectrodynamics and Biocommunication*, ed. by Ho, M.W., Popp, F.A., and Warnke, U., World Scientific, Singapore (1994)
 57. Popp, F.A.; Gu, Q.; and Li, K.H.; "Biophoton Emission: Experimental Background and Theoretical Approaches," *Mod. Phys. Lett. B*, Vol. 8, Nos. 21 & 22, pp. 1269-1296 (1994a)
 58. Popp, F.A., Chang, J.J., Herzog, A., Yan, Z., and Yan, Y., "Evidence of Non-Classical (Squeezed) Light in Biological Systems," *Physics Letters A*, Vol. 293, Nos. 1-2, pp. 98-102 (2002)
 59. Popp, F.A., "Properties of Biophotons and Their Theoretical Implications," *Indian Journal of Experimental Biology*, Vol. 41, May, pp. 391-402 (2003)
 60. Popp, F.A., "Biophysical Aspects of the Psychic Situation," International Institute of Biophysics,
http://www.lifescientists.de/ib0203e_1.htm
(2006)
 61. De Sabbata, V., and Gasperini, M., "A Semi-Minimal Coupling Principle for the Electromagnetic Field in Space with Torsion," *Lett. Nuovo Cim.* Vol. 28, No. 7, p. 229, June (1980)
 62. De Sabbata, V., and Gasperini, M., "Torsion Production by Electromagnetic Fields," *Lett. Nuovo Cim.*, Vol. 30, No. 12, p. 365, March (1981)
 63. Saxl, Erwin J., "An Electrically Charged Torque Pendulum," *Nature*, 11 July 1964, pp. 136-137 (1964)
 64. Saxl, Erwin J., "Device and Method for Measuring Gravitational and Other Forces," U.S.Patent 3,357,253, granted Dec. 12 (1967)
 65. Saxl, Erwin J., and Allen, Mildred, "Period of a Torsion Pendulum as Affected by Adding Weights," *Journal of Applied Physics*, Vol 40, No. 6, May 1969, pp. 2499-2504 (1969)
 66. Saxl, Erwin J., and Allen, Mildred, "1970 Solar Eclipse as 'Seen' by a Torsion Pendulum," *Physical Review D*, Vol. 3, No. 4, 15 Feb 1971, pp 823-825 (1971)
 67. Saxl, Erwin J., and Allen, Mildred, "Electronic Recording of Length Changes of a Wire During Dynamic Torsion," *Journal of Engineering Materials and Technology-Technical Briefs, Transactions of the ASME*, January, p. 92 (1975)
 68. Shaduri, Marina, "Secondary Holographic Radiation of Biological Systems," *Kybernetes*, Vol. 34, No. 5, pp. 666-680 (2005a)
 69. Shaduri, Marina, "Integrative Functional System of Living Systems," *Functional Diagnostics*, Vol. 1 (2005b)

70. Shakhparonov, I. M., "Kozyrev-Dirac Emanation: Methods of Detecting and Interaction with Matter," *Journal of New Energy*, Vol. 2, No. 3-4 (1998)
71. Shakhparonov, Ivan M., "Interaction Between Kozyrev-Dirac Radiation and Radionuclides," *Journal of New Energy*, Vol. 3, No. 4, Spring (1999)
72. Shakhparonov, Ivan M., "Interaction of Matter and Methods of Detecting," *New Energy Technologies*, Vol. 1, p 275-280 (2001)
73. Shakhparonov, I.M., Grin, S.A., Tsimbalaev, S.R., Kreindel, L.N., Kocheshkova, V.N., Podlesny, A.I., and Gelfand, S. Yu, "Effect of Magnetic Blow Wave Field on Wine Systems," *New Energy Technologies*, #2(5) (2002)
74. Shapovalov, A., "The Instrument 'Got Mad'", *Tekhnika – Molodezhi (Engineering for the Youth)*, N6, pp. 28-29 (1973)
75. Shipov, G. I., "Unification of Interactions in the Theory of Physical Vacuum," (2002)
76. Shpilman, Alexander A., "Spin (Axion) – Field Generator", sah@kaznet.kz, p. 306, *New Energy Technologies*, Vol. 1, or see <http://www.pmicro.kz/Misc/UFL/Almanach/2n01/MedeoA.htm> (2001)
77. Shikhobalov, Lavrety S., "N.A.Kozyrev's Ideas Today," *New Energy Technologies* Vol. #2(5) (2002)
78. Popp, F.A., "Molecular Base of Life," International Institute of Biophysics, http://www.biophotonik-international.de/publications/molecular_base_of_life.htm (2008)
79. Shipov, G. I., "Theory of the Physical Vacuum," NT-Center, Moscow (1993)
80. Sit'ko, S.P., Gizhko, V.V., "On the Microwave Coherent Field of the Human Body and the Nature of Chinese Meridians," *Journal of Biological Physics*, Vol. 16, p. 73-76 (1988)
81. Sit'ko, S.P., *Physics of the Alive*, The Vidhuk Scientific Research Center, Vol. 1 (1993)
82. Sit'ko, S.P., Mkrтчian, L.N., *Introduction to Quantum Medicine*, Pattern, Kiev (1994a)
83. Sit'ko, S.P., *Physics of the Alive*, The Vidhuk Scientific Research Center, Vol. 2 (1994b)
84. Swanson, Claude, *The Synchronized Universe- New Science of the Paranormal*, (also referred to as "Volume I"), Poseidia Press, Tucson (2003)
85. Swanson, Claude, *Life Force: The Scientific Basis*, Poseidia Press, Tucson (2009)
86. Tiller, William A., Dibble, Walter E., and Kohane, Michael J., *Conscious Acts of Creation - The Emergence of a New Physics*, Pavior Publishing, Walnut Creek, California (2001)
87. Tiller, William A., Dibble, Walter E., and Fandel, J. Gregory, *Some Science Adventures with Real Magic*, Pavior Publishing, Walnut Creek, California (2005)
88. Veinik, A.I., "Termodinamika realnykh protsessov," Minsk. Nauka i Tekhnika, (in Russian) (1991)
89. Volkamer, Klaus, Streicher, Christoph, Walton, Kenneth G., Fagan, John, Shenklung, Hartmut, and Marlot, Harry, "Experimental Re-Examination of the Law of Conservation of Mass in Chemical Reactions", *Journal of Scientific Exploration*, Vol. 8, No. 2, pp. 217-250 (1994)

∞ ∞ ∞

